

BD15LR DC brushless motor driver

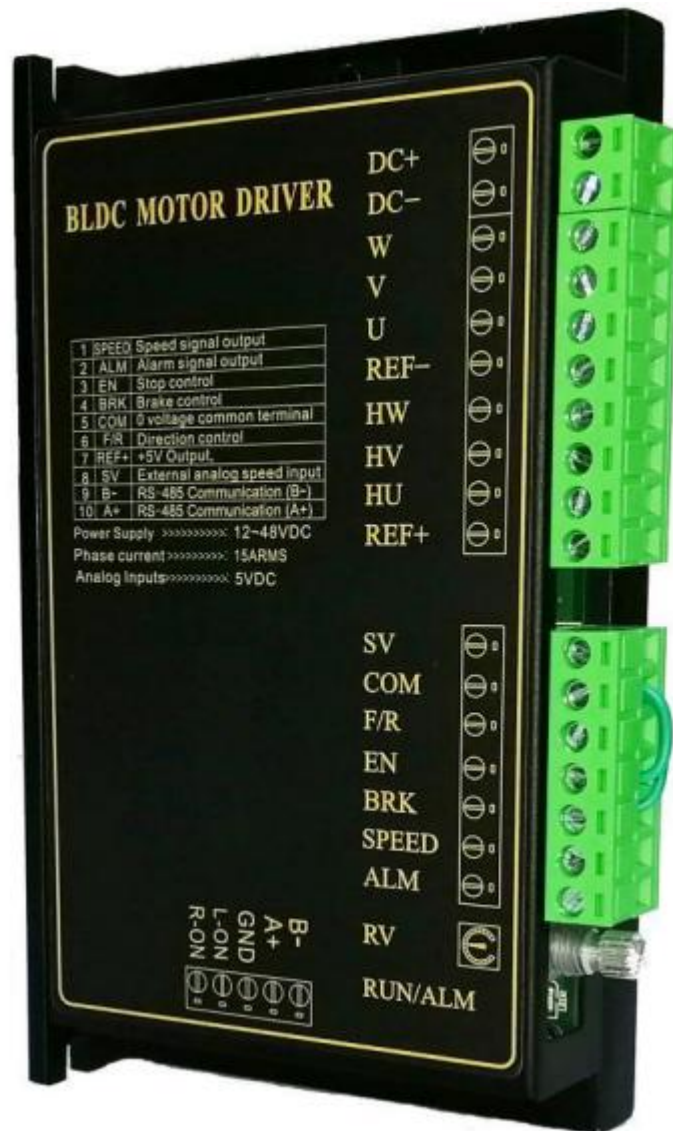

Overview:

BD15LR is a high-performance DSP as the computing core, a multi-function control mode DC brushless driver. The all-digital design enables it to have flexible and diverse input control methods, complete software and hardware protection functions, and the driver can be connected to the computer through the RS-485 communication interface to achieve parameter adjustment, protection parameters, motor parameters, acceleration and deceleration time and other parameters.

Introduction:

- Acceleration/deceleration time setting
- Motor pole number selection
- Open/closed loop control
- Maximum current output setting
- Motor stall torque retention
- Various alarm indications
- Built-in potentiometer RV speed control
- External potentiometer speed control Control
- External analog signal speed control
- PWM speed control
- RS-485 communication control
- Automatic reset and restart after alarm

Installation dimensions(mm):

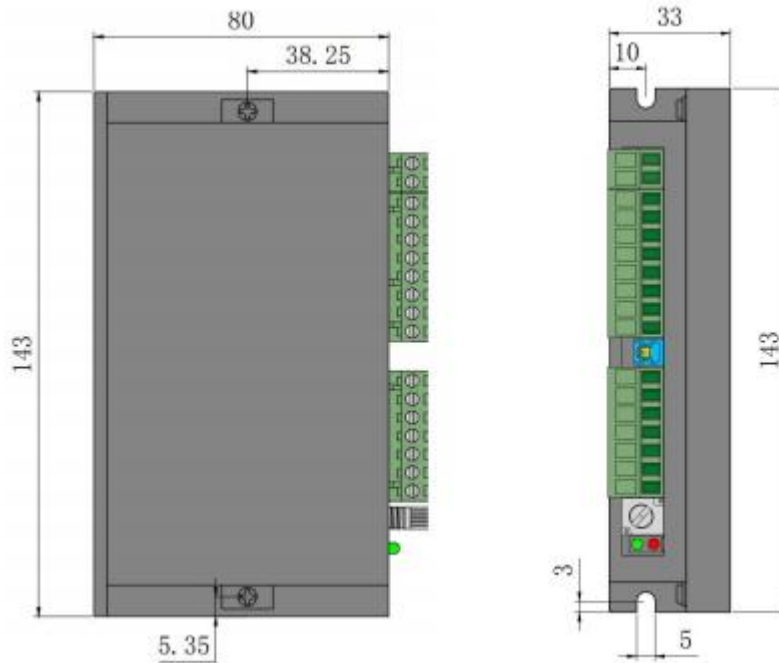

Electrical parameters:

parameter	Minimum	Typical value	maximum	unit
Input voltage	10	24	60	VDC
Output current	1	15	15	A
Applicable motor speed	100	3000	20000	RPM
Low voltage protection	14			VDC
Over voltage protection			60	VDC
Speed control mode	1. 0-5VDC analog input 2. 0-100% PWM input (PWM frequency range: (1Kz-20KHz)) 3. External potentiometer speed regulation 4. Set via RS-485 communication			
Over current protection	Over current protection occurs when the current exceeds the set value of the working current and lasts for a set time			
Under voltage protection	Under voltage protection occurs when the voltage is lower than 14V			
Over voltage protection	Over voltage protection occurs when the voltage exceeds 60V			
Hall abnormal	Hall signal abnormal value			
Acceleration and deceleration time setting	The acceleration and deceleration time can be set through the software host computer software			

Environmental indicators:

Envirnmental factor	Environmental indicators
Cooling method	Natural cooling or forced cooling

Use occasion	Avoid dust, oil and corrosive gases
Operating temperature	10°C -+50°C
Environment humidity	90%RH (No condensation)
Humidity	5.7m/S2max
Storage temperature	0°C -+50°C

Driver interface and wiring diagram:

Drive interface



Port signal description:

Signal	Terminal	Content
Output signal	ALM	The motor or driver controls the fault signal output signal, which is normally 5V, and the level is 0V when the fault occurs.
	SPEED	Corresponding to the operating speed of the motor, the corresponding pulse frequency is output. With PG, the speed of the motor can be calculated. The calculation formula is: $N(\text{rpm}) = (F/P) * 60/3$ F: Output pulse frequency (HZ) ; P: Motor grade logarithm; N: Motor speed For example: motor 4 pole $F = 1 \text{ sec} / 2 \text{ ms} = 500 \text{ Hz}$ $N(\text{rpm}) = (500/4) * 60/3 = 2500$
Control signal	BRK	When the BRK and COM terminals are disconnected or the high level is input, the motor brake stops. When the motor is shorted or low level, the motor runs.
	EN	When the EN terminal is disconnected from the GND terminal or the high-level input is input, the motor stops slowly. When the short-circuit or low-level input is used, the motor runs.
	F/R	When the F/R terminal is short-circuited with the GND terminal or the high-level input, the motor rotates forward, and when the short-circuit or low-level input is used, the motor reverses.
	GND	Public port (OV reference level)
	SV	①external speed potentiometer ②external analog signal input ③PWM signal input
	A+	RS485 communication
	B+	RS485 communication
Hall signal	REF+	DC brushless motor Hall signal power supply.
	HU	DC brushless motor Hall signal HU.
	HV	DC brushless motor Hall signal HV.
	HW	DC brushless motor Hall signal HW.
	REF-	The DC brushless motor Hall signal is grounded.
Motor connection	U	DC brushless motor U phase.
	V	DC brushless motor V phase.
	W	DC brushless motor W phase.

Power connection	DC-	DC power input to the negative pole.
	DC+	The DC power input is positive. (Voltage range DC24V-DC60V)

Output signal diagram

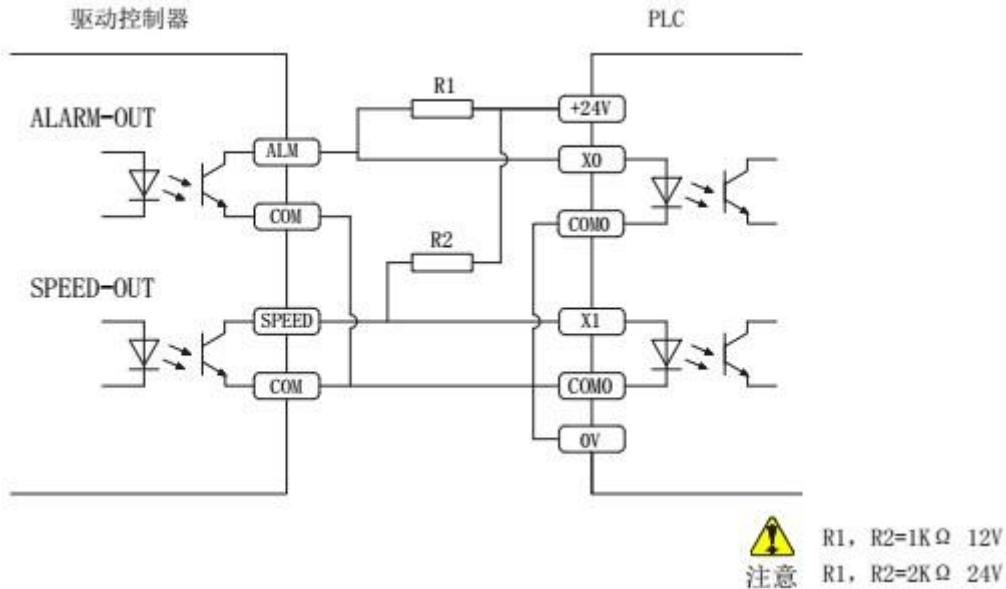

Restart function after alarm When the motor is locked, the drive will stop working for 3 seconds, and then the drive will automatically start. After restarting, if there is another fault, it will alarm, the protection function will be activated, and it will stop working.

Start and stop (EN)

The factory setting of the EN and GND terminals is to open the EN and GND terminals. When the power is turned on, the motor does not run. Requires both EN and BRK to be connected to GND to run. Connect or disconnect the EN and GND terminals to control the running and stopping of the motor. The motor starts when the EN terminal and the GND terminal are connected. Otherwise, the motor will decelerate and stop.

◆By connecting a switch between EN and GND or using PLC to control its on-off, the switch between start and stop of the motor can be realized.

Fast stop(BRK)

The factory setting of the BRK terminal and the GND terminal is that the BRK terminal and the GND terminal are open. When the power is turned on, the motor does not run. Requires both EN and BRK to be connected to GND for operation. Connect or disconnect terminals BRK and GND to control motor start and quick stop. When disconnecting the connection wire between the BRK terminal and the GND terminal, the motor stops quickly.

◆By connecting a switch between BRK and GND or using PLC to control its on-off, the switch between motor start and brake stop can be realized.

The difference between EN and BK and their use options:

①EN control is natural stop; BRK control is quick stop

②EN and BK control have the same starting state.

③When one of the modes of EN or BRK is selected to control the start and stop, the wiring of the other mode should be kept connected.

Direction control(F/R)

The factory setting of the F/R terminal and the GND terminal is that the F/R terminal and the GND terminal are not connected. When the power is turned on, the motor rotates forward. Connecting or disconnecting the F/R terminal and the GND terminal can control the forward and reverse rotation of the motor. When disconnecting the F/R terminal and the GND terminal, the motor reverses. When connecting the connecting wire between F/R terminal and GND terminal, the motor rotates forward.

The choice and setting of the speed control mode:

Speed control with built-in potentiometer RV

Turn the built-in speed potentiometer RV clockwise and the motor starts to run. Continue to rotate clockwise and the motor speed increases. Rotate the built-in speed potentiometer RV counterclockwise to reduce the motor speed; continue to rotate counterclockwise to the minimum limit position. At this time, the built-in speed regulating potentiometer RV is closed, and the motor stops running.

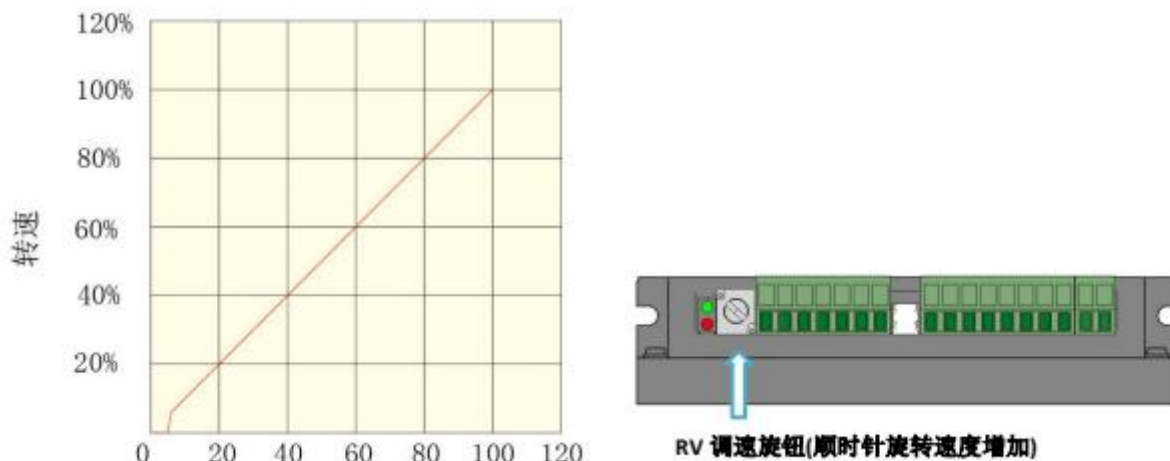

Use an external potentiometer to adjust speed

When using an external speed potentiometer to adjust the speed, please use a suitable potentiometer with a resistance value of 10KΩ. The middle terminal of the potentiometer is connected to the SV terminal, and the terminals on both sides are respectively connected to the 5V and GND terminals.

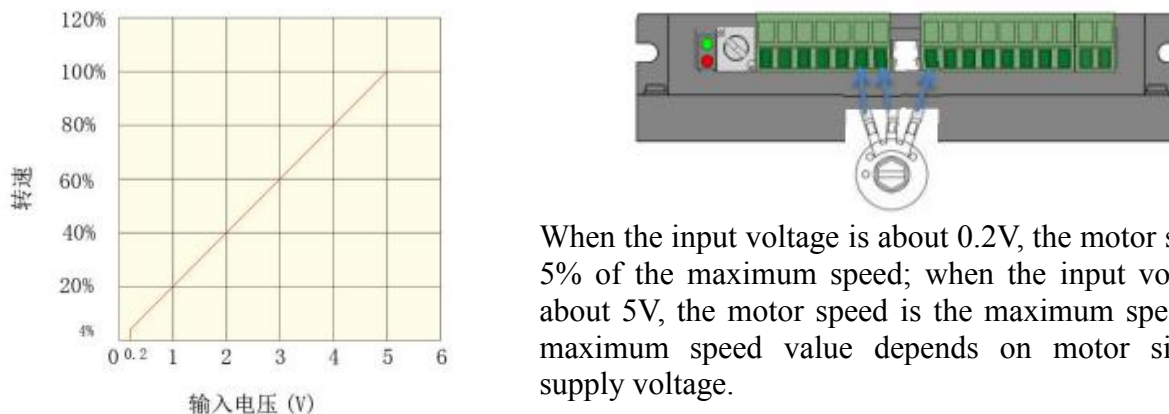

When the input voltage is about 0.2V, the motor speed is 5% of the maximum speed; when the input voltage is about 5V, the motor speed is the maximum speed. The maximum speed value depends on motor size and supply voltage.

Using PWM speed control (external analog speed control)

When it is necessary to switch to the external SV input control speed mode, the built-in potentiometer RV must be turned counterclockwise to the minimum state. That is, turn the built-in potentiometer RV counterclockwise to the limit position.

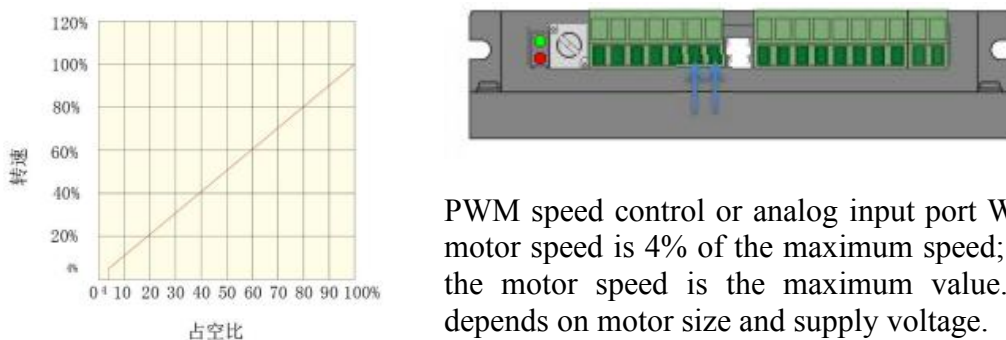

PWM speed control or analog input port When the duty cycle is 4%, the motor speed is 4% of the maximum speed; when the duty cycle is 100%, the motor speed is the maximum value. The maximum speed value depends on motor size and supply voltage.

Status indication. Exception handling:

Status indication

When the motor has over current, Hall input error, stall, over temperature, over voltage, etc., the driver will send an alarm signal.

At this time, the fault alarm output (ALM) and the common terminal (COM) will be turned on, so that the fault alarm output (ALM) becomes low, and at the same time the driver stops working and the alarm light flashes.

Alarm indication	Status description	LED indicates details
Red light flashes 2 times	Over voltage alarm	
Red light flashes 3 times	Power tube Over current alarm	
Red light flashes 4 times	Over current alarm	
Red light flashes 5 times	Under voltage alarm	
Red light flashes 6 times	Hall alarm	
Red light flashes 7 times	Blocking alarm	
Red light flashes 8 times	Two or more alarms	

Exception handling

Red light indication	Status description	Solve method
Red light flashes 2 times	Over voltage alarm	Please check the bus voltage
Red light flashes 3 times	Power tube Over current alarm	Determine if the model is correct
Red light flashes 4 times	Over current alarm	Check the P-sv settings and check the motor parameters. Or increase the acceleration time
Red light flashes 5 times	Under voltage alarm	Check the power supply voltage and check if the power supply meets the condition of 1.5 times the motor power.
Red light flashes 6 times	Hall alarm	Please check if the motor wiring is secure
Red light	Blocking alarm	Please determine if the motor is overloaded

flashes 7 times		
Red light flashes 8 times	Two or more alarms	Common conditions are only for Hall and stall alarm. When the motor cannot be adjusted, please adjust P-sv to the maximum value.

MODBUS RS485 communication:

The company's series of drive controllers provide users with a common RS485 communication interface in industrial control. The communication protocol adopts the MODBUS standard communication protocol. The controller can be used as a slave to communicate with the host computer (such as PLC controller and PC) which has the same communication interface and adopts the same communication protocol to realize centralized monitoring of the controller. The address broadcast function can be used to realize the multi-machine linkage and synchronous action of the controller. The MODBUS communication protocol of this controller is RTU mode, the following is the detailed description of the communication protocol of this controller

项目	参数
从机台数	255 台
波特率	9600bps
数据交换方式	异步串行, 半双工
传送协议	MODBUS 通讯协议 RTU
数据位	8 位
停止位	1 位
校验位	无
错误检查方式	CRC16 校验
帧长度	8 字节固定

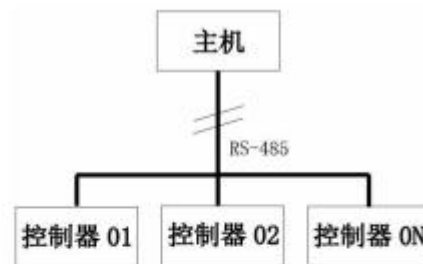

(1) 多机连接组网方式



8.1: Communication protocol mode

PC or PLC can work as the host to control the drive. The specific communication methods are as follows:

- (1) The drive is a slave machine, and the master-slave type point-to-point communication.
- (2) The drive is a slave, and the master controls multi-slave communication.
- (3) When the master uses the broadcast address to send commands, multiple slaves run synchronously. When the master uses the broadcast address to send commands, the slaves do not respond.
- (4) MODBUS communication protocol RTU mode.

8.2: Write data description

The transmission mode is asynchronous serial, half-duplex transmission mode. At the same time, only one of the master and the slave can send data, and the other can only receive data. In the process of serial asynchronous communication, data is sent frame by frame in the form of messages.

For example: Slave address 1 as an example.

Step 1: Send 485 enable: 010600B60001A9EC Slave return: 010600B60001A9EC 485 enable can only be sent once per power-on, and the delay can be more than 150MS.

Step 2: Send forward rotation command: 010600660001A815 Slave return: 010600660001A815 Set the motor to forward rotation with a delay of more than 150MS.

Step 3: Send speed command: 0106005603E86964 Slave return: 0106005603E86964 Set the speed to 1000 rpm and delay more than 150MS.

For other functions, please refer to the following write data table for control settings.

The following is the slave address is 1, the function code and check code when writing, if the value changes, the CRC check code should be recalculated according to RTU.

从机地址 (1byte)	功能码 (1byte)	访问地址 (2byte)	访问数据 (2byte)	CRC 校验 (2byte)	功能说明
0X01	0X06 (写数据)	0X00B6	0X0001	0XA9EC	RS-485 有效控制
0X01	0X06 (写数据)	0X00B6	0X0002	0XE9ED	RS-485 无效
0X01	0X06 (写数据)	0X0089	0X0000	0X5820	设定为开环控制
0X01	0X06 (写数据)	0X0089	0X0001	0X99E0	设定为闭环控制
0X01	0X06 (写数据)	0X00A6	0X0001	0XA829	RS-485 地址设定为 1
0X01	0X06 (写数据)	0X0056	0X03E8	0X6964	设定电机转速 1000 转
0X01	0X06 (写数据)	0X0066	0X0000	0X69D5	电机停止
0X01	0X06 (写数据)	0X0066	0X0001	0XA815	电机正转
0X01	0X06 (写数据)	0X0066	0X0002	0XE814	电机反转
0X01	0X06 (写数据)	0X0066	0X0003	0X29D4	电机刹车停止
0X01	0X06 (写数据)	0X0090	0X0708	0X8A11	设定电流限制 5A (5*360)=0X0708
0X01	0X06 (写数据)	0X0086	0X0004	0X69E0	电机磁极对数设定 4 对极
0X01	0X06 (写数据)	0X0088	0X0001	0XC820	过流保护时间设定 1S
0X01	0X06 (写数据)	0X0093	0X00C8	0X7871	设定加速时间 200MS
0X01	0X06 (写数据)	0X0094	0X00C8	0XC9B0	设定减速时间 200MS

8.3: Instructions for reading data

For example: slave address 1 as an example.

Send read speed command: 0103005F0001B418 Slave return: 01030203E8XXXX Read motor speed of 1000 rpm, CRC check will delay more than 150MS according to the read speed change.

Send read current command: 010300C600016437 Slave return: 01030203E8XXXX Read current parameter (1000/100)=10A Read current 10A with a delay of more than 150MS.

从机地址 (1byte)	功能码 (1byte)	访问地址 (2byte)	访问数据 (2byte)	CRC 校验 (2byte)	功能说明
0X01	0X03 (读数据)	0X005F	0X0001	0XB418	读取电机实际转速
0X01	0X03 (读数据)	0X0076	0X0001	0X65D0	读取报警代码
0X01	0X03 (读数据)	0X00C6	0X0001	0X6137	读取实际电流值 /100
0X01	0X03 (读数据)	0X00C8	0X0001	0X05F4	读取供电电压值 /10