

RichAuto--AutoNow B11 Motion Control System

User's Manual

Download manual from
www.richnc.com.cn
www.richauto.com.cn

北京锐志天宏科技股份有限公司

Beijing RichAuto S&T Co., Ltd.

Add : 5F, No.4 building, No. 4 Yard, Shengmingyuan Road, Zhongguancun Life Science Park
Beiqing St., Changping District, Beijing 102206 China Tel/Fax :(+86)-010-53275118/53275119

Thank you for choosing RichAuto products!

This manual helps you be familiar with the company's products, and get information about systems' components, configuration etc.

This manual contains detailed knowledge of the system characteristics、operating procedures, installation & commissioning, and safety precautions. Please read this manual carefully before using the system and machine, which will help you to use it better.

Cautions:

1. It's strictly prohibited in the strong interference and strong magnetic field environment. Operating ambient temperature: 0-70 °C; Environment humidity: 0-90% (non-condensing).
2. Insert U disk in the correct direction. Do not pull out or insert 50-pin signal transmission cable when system is powered on.
3. During the perform processing in U disk file, do not pull out the U disk to prevent the interruption of data transmission.
4. Strictly prohibited metal, dust, and other conductive substances drop into the handheld controller shell.
5. The machine casing shall be well grounded to ensure work safety and prevent interference.
6. Unauthorized removal is strictly prohibited, no internal user repairable parts.
7. For long time not using, please power off and keep it properly.
8. Be careful to prevent it from water, dust, fire when using.
9. Do not use the corrosive chemical solvents to clean the device.
10. Spindle motor bearing life and its speed is inversely proportional.
11. The tool bit is very sharp. Do not touch when it is running, in order to avoid injury; Do not use handkerchiefs, scarves to approach it to prevent embroiled damage.

Important statement:

The Company shall not be responsible for any loss caused by improper using or failure to comply with the rules of operation.

Beijing RichAuto S&T Co., Ltd owns final interpretation of this manual, we reserves the rights to revise all information in this manual, including data, technical details, etc.

Content

FOREWORD	1
1. System Introduction:	1
2. Performance Feature:	1
3. Product Parameters:	2
4. Model List:	2
1 RichAuto System Composition	3
1.1 RichAuto System Composition.....	3
1.2 Components description.....	4
1.2.1 Handle	4
1.2.2 Interface board.....	5
1.3 Mounting dimensions.....	5
1.4 System startup methods	6
2 Keypad Introduction.....	6
2.1 Buttons introduction	6
2.2 Buttons usage method	7
2.3 Buttons function details	8
3 Wiring description	10
3.1 Interface board terminal	10

3.2	Interface board I/O ports	10
3.3	Hardware wiring.....	13
3.4	Commissioning of machine tool and control system	18
4	<i>MENU description.....</i>	18
4.1	Menu category	18
4.2	Menu details	19
4.2.1	Machine Setup.....	19
4.2.2	Auto Pro Setup	23
4.2.3	System setup	27
4.2.4	File operate.....	33
4.2.5	Version view	34
5	<i>Machine Tool Operation.....</i>	35
5.1	HOME operation	35
5.2	Import processing file.....	35
5.3	Manual processing operation	35
5.3.1	Manual speed switching and adjusting.....	35
5.3.2	Manual movement modes	37
5.3.3	Manual testing input & output	38
5.3.4	Manual switching coordinate system.....	38
5.4	Auto processing operation.....	40
5.4.1	Set work origin.....	40
5.4.2	Select processing file.....	40

5.4.3	Set processing parameters.....	41
5.5	Operations during processing.....	42
5.5.1	Speed ratio& spindle state adjusting	42
5.5.2	Pause & position adjustment	42
5.5.3	Break work & power failure protection.....	43
5.6	Advanced work	46
5.6.1	Array work.....	47
5.6.2	Resume work.....	48
5.6.3	Tool changing	48
5.6.4	Part work.....	48
5.6.5	Calculate bound.....	49
5.6.6	Mill plane.....	50
5.6.7	Calculate work time	51
5.6.8	Find break no.....	51
5.6.9	Scale work	52
PS1	System upgrade operation	53
PS2	“Flash disk mode” function introduction	54
PS3	G code reference list.....	55
PS4	Tool setting details.....	57
PS4.1	Direct tool setting.....	58
PS4.2	Fixed calibration.....	58
PS4.3	Mobile calibration.....	60

PS5 Pulse equivalent calculation.....	62
PS5.1 Stepper motor drive	62
PS5.1.1 Linear axis	62
PS5.1.2 Linear axis pulse equivalent calculation method.....	64
PS5.1.3 Rotary axis (pul/ °).....	65
PS5.1.4 Rotary axis pulse equivalent computing	65
PS5.2 Servo motor drive.....	66
PS5.2.1 Linear axis	66
PS5.2.2 Calculate electronic gear ratio according to fixed pulse equivalent value	66
PS5.2.3 Calculate pulse equivalent according to fixed electronic gear ratio	68
PS5.2.4 Rotation axis.....	69
PS5.3 Proportion calculation method.....	70
PS6 Common troubleshooting.....	70
PS6.1 Solution of screen prompts fault information	70
PS6.2 FAQ in practical operation.....	72
PS6.3 Electrical components and wiring problem.....	75

FOREWORD

1. System Introduction:

RichAuto B1X motion control system independently developed by Beijing RichAuto S&T Co., Ltd and it can be widely applied to machinery, advertisement, wood working, mold engraving machines, laser, flame, plasma cutting machines, and others in the machine control field.

RichAuto B1X makes DSP as the core of its system, High-speed processing; Use embedded structure, high degree of integration and strong stability make installation and operation easy; Support U disk, removable storage card reader; High speed transfer, no longer dependent on the computer to realize off-line operation.

2. Performance Feature:

- 1) System standard configuration is X, Y, Z 3-axis motion control method, support double Y axis output control.
- 2) Multiple I/O ports control. Standard equipped with I/O signal node which has 8 inputs and 7 output signals.
- 3) Support the standard G code, PLT format instructions; support domestic and international mainstream CAM software, such as: **Type3, Artcam, UG, Pro/E, MasterCAM, Cimatron, Ucamcam etc.**
- 4) Provide with power failed protection. System automatically save the current processing information in the moment of sudden power down (file name, current line number, work speed, spindle state); After powered up and returned HOME position, the system automatically prompts the user to restore the processing before power down which makes processing operations become more humanity.
- 5) Support breakpoint memory, select file line No. processing. Can save 8 different breakpoint processing information.
- 6) Multi-coordinate memory function. Provide 9 working coordinate system. The User can switch among the 9 coordinates, each coordinate system can save a process origin information.
- 7) Support adjusting spindle operating frequency (or spindle rotate speed). The spindle frequency is divided into 8 shifts. During processing, user can adjust shifts directly by keys without suspend processing.
- 8) Support adjusting speed ratio during operation. To adjust the speed ratio so as to change the processing speed and travel speed, speed ratio values from 0.1-1. Increasing or decreasing 0.1 per time.
- 9) Simple manual operate mode. In manual mode, the system provides 3 kinds of move modes, including continuous, step, and distance, become more simple and convenient.
- 10) Identifies M code, F code and other extended instructions, and it can also open a special code based on user's needs.

- 11) Built-in 512 M memory. Adapt USB communication port with high efficiency for file transfer. Can read files in U disk and card reader directly.
- 12) Unique handheld structure which can be hold with one hand. With LCD display and 24 keys operation keyboard, intuitive and flexible operation, no longer rely on the computer, completely offline operation.
- 13) Self-detection function. The system comes with I/O ports signal detection function, easy remote maintenance.
- 14) System supports automatic dynamic upgrade, which is convenient for remote operation and maintenance.

3. Product Parameters:

Model No.	RichAuto-B11		
CPU	DSP	CPU	DSP
Built in memory	512MB	Built in memory	512MB
Display screen	128*64Monochrome LCD	Display screen	128*64Monochrome LCD
Communication port	U disk	Communication port	U disk
Linkage axis No.	3 axes	Interpolate method	Straight line, arc, spline curve
Control signal	5V common anode	Soft / hard limit	Support
Driving system	Stepper / servo motor	Maximum pulse frequency	1MHz
Minimum input unit	0.001mm	Password protection	Support
Languages	English, Simplified Chinese, Traditional Chinese, other languages can be customized		
Standard layout	Handheld controller with USB adapter 1pc; 50 pins cable 1 pc、 I/O interface board 1 pc, USB data cable 1 pc		

4. Model List:

<i>AutoNow</i>	Model No.	Name
3 inches Monochrome screen B1X series motion control system	B11	3 axis motion control system

1 RichAuto System Composition

1.1 RichAuto System Composition

RichAuto control system contains the following parts: 1pc of hand-held controller (handle), 1pc of interface board, 1pc of 50-pin data transmission cable, 1pc of USB communication cable.

RichAuto system accessories:



Hand-held controller

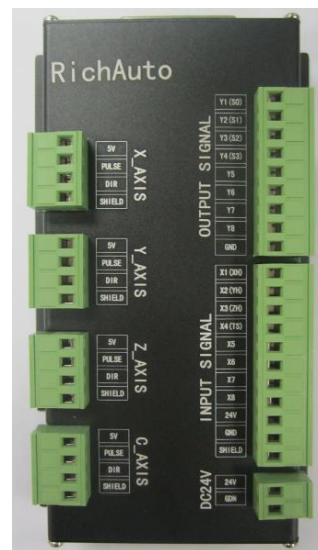

Interface board



Both ends tenon type
data transmission cable



USB communication

1.2 Components description

1.2.1 Handle

As shown below, including 6 parts:



1) LCD screen: 128 * 64 resolution LCD display, to display the machine motion, system settings and other information.

2) Key area: Contains 24 buttons to set system parameter information and the machine movement control operation.

3) U disk adapter: External memory like U disk and the card reader throw-over access port. It can identify the files from external memory; System format is FAT16/32 format. This part can be removed separately if it is damaged.

4) RichAuto LOGO

5) 50-pin cable socket: To realize the connection between the system and the machine tool via 50-pin cable. The motion signal given by the system is transmitted to the machine tool motion actuator.

6) USB communication interface: The port of USB communication cable. It is used to connect the handle and computer.

1.2.2 Interface board

As shown below, including 5 parts:

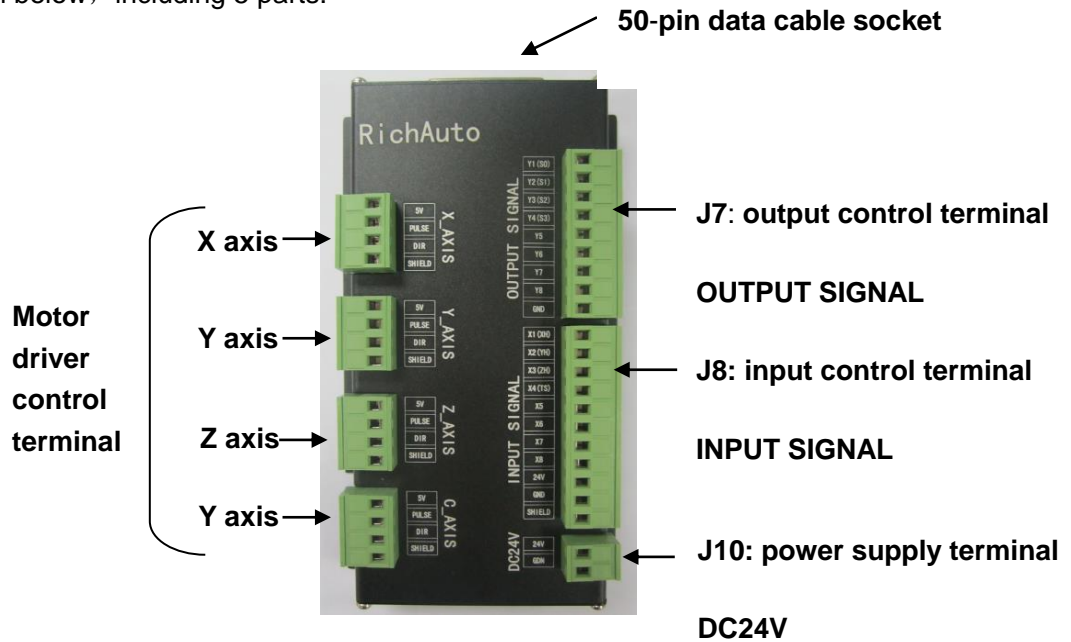

- 1) 50-pin data cable port: Connect handle with interface board.
- 2) Output control terminal: Including spindle On/Off signal, work & alarm led signal etc.
- 3) Input control terminal: Including machine origin detection switch, tool setting, driver alarm, hard limit switch, and E-stop signal, pedal switch.
- 4) Power supply terminal: DC24V,3A
- 5) Motor driver control terminal.

1.3 Mounting dimensions

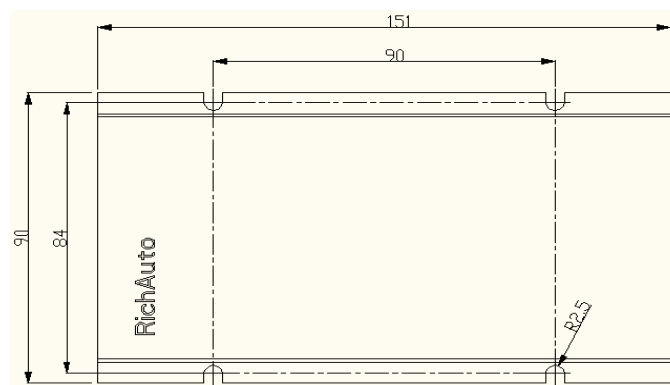

Scale 1:1, unit mm

1.4 System startup methods

RichAuto-B1X motion control system contains 2 starting methods:

Normal starting: Normal power on the system, after boot it will enter into HOME TYPE interface and manual control interface.

Emergency starting: If normal starting cannot show any words or manual interface, emergency starting is required.

Power off the system first, then keep pressing “” and don’t release it, power on the

controller and waiting for 3-4 seconds. Release “”, it will enter into Emergency State interface, user could either select System Update or Format System or restart the system directly without any selection.

2 Keypad Introduction

2.1 Buttons introduction

RichAuto handheld control system has defined 24 operation buttons, each one provides one or more functions in different working states:

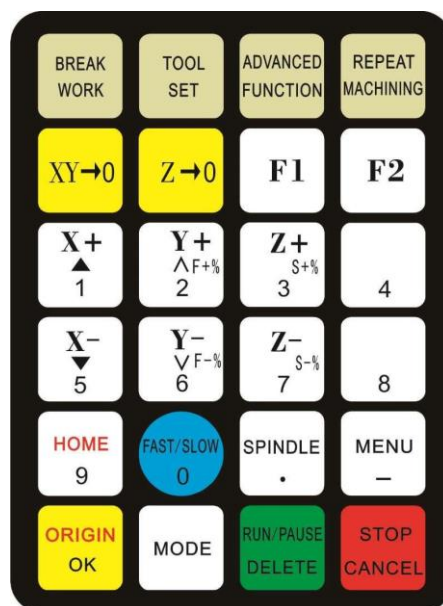



2.2 Buttons usage method

RichAuto provides 2 modes of button operations, including one-touch key & Combination keys.









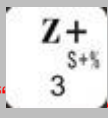
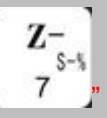

One-touch key: Press one key on the handheld controller keypad is executing the single key operation.

Combination keys: Press two keys at the same time to achieve certain function is executing combination keys operation; The operation steps: press one **main function key** not release it, meanwhile press a second **auxiliary function key**, and then release the two buttons at the same time to realize the combination keys operation. For instance, the

system upgrade combination keys are “” + “”. When operation, user could





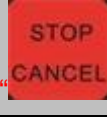



push the main function key “” first, push auxiliary function key “” then, at last release both of them at the same time.

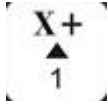

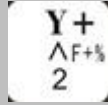
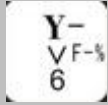
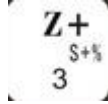
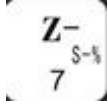

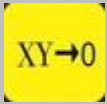





Commonly used combination keys:

	Combination Keys	Function
1	 “  ” + “ 0-9 ” numeric key	Coordinates systems switching keys 0 is mechanical coordinate system 1-9 are working coordinate system
2	 +  / 	Switching spindle shifts in manual mode
3	 + 	Set current position as parking position
4	 + 	System upgrade
5	 + 	Input coordinate parameter to move the equipment
6	 + 	Exit keyboard detection interface

Note: Users can also find the corresponding combination keys operations list at the back of the handle.

2.3 Buttons function details

Key Name	Function
 	<p>X axis positive/negative movement;</p> <p>Menu up/down selection;</p> <p>figure 1,5 input</p>
 	<p>Y axis positive/negative movement;</p> <p>work speed up/down selection;</p> <p>figure 2, 6 input</p>
 	<p>Z axis positive/negative movement;</p> <p>spindle speed up/down selection;</p> <p>figure 3,7 input</p>
	<p>figure 4 input</p>
	<p>Figure 8 input</p>
	<p>Set X axis and Y axis work origin;</p>
	<p>Set work origin of Z axis;</p>
	<p>Operation of return machine zero point (HOME) in manual mode; Figure 9 input</p>
	<p>FAST/LOW motion state switching in manual mode;</p> <p>work coordinate/ mechanical coordinate switching in auto mode; figure 0 input</p>
	<p>Decimal input;</p> <p>spindle ON/OFF in manual mode</p>

	Enter MENU setting; View work information during processing; negative sign
	Return work origin; OK key of all selections, inputs and operations
	Manual motion states; Continuous, step, distance 3 modes switching
	RUN/ PAUSE processing file; DELETE the input data; Selection of different attribute in MENU
	Motion parameter adjustment in manual mode; processing termination; Cancellation of various options, inputs and operations during processing
	System reserved function button
	System reserved function button
	Breakpoint processing combination main function key (support the figure 1 to 8)
	Enable Z axis automatic tool setting function
	Enable advanced processing function
	Repeat machining same (previous) processing file

3 Wiring description

3.1 Interface board terminal

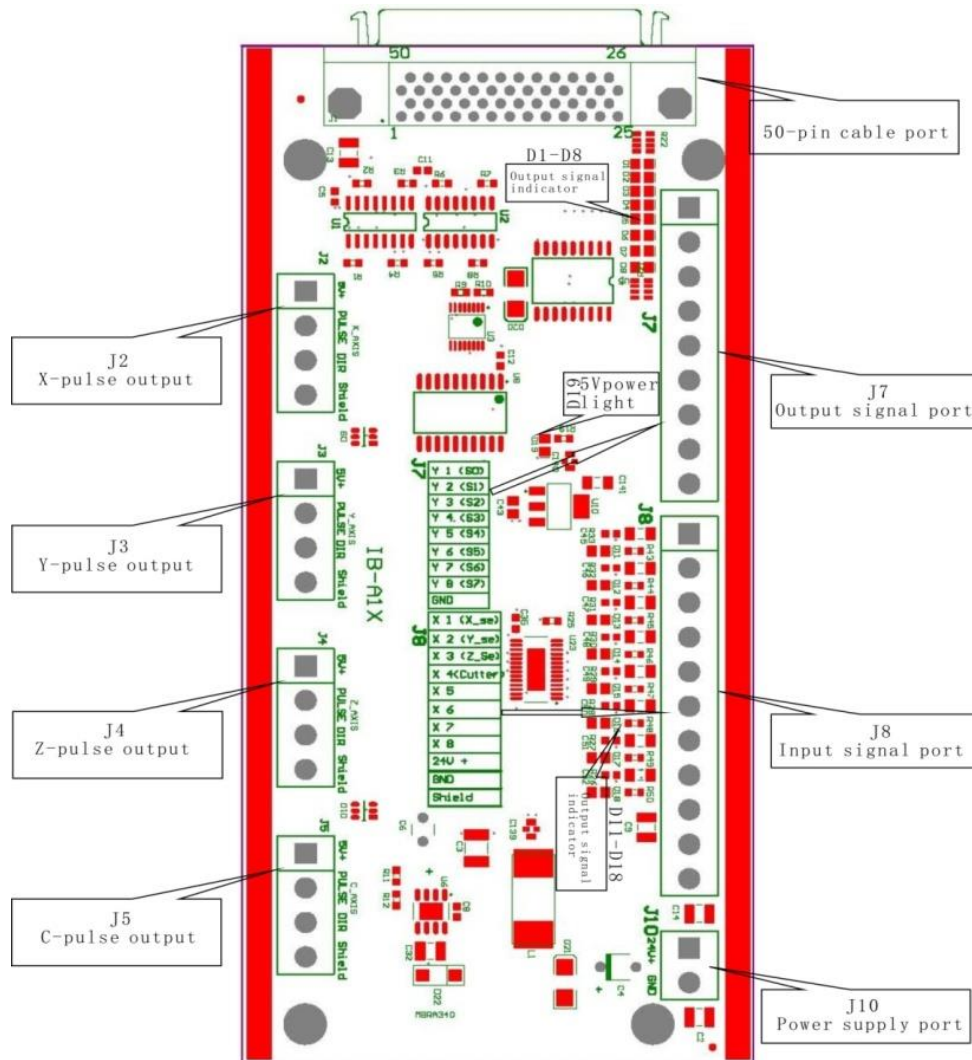

3.2 Interface board I/O ports

Port label	Port definition	Signal description	Pin functions and parameters	Notes
DC	24V+	+24V DC power input	Supply DC24V to interface board after	The recommended

	24V-	-24V DC power input	power on	power supply is DC24V ($\geq 3A$)
X_AXIS	5V	X common anode	Common anode power supply of X axis driver provides 5V output	Do not impose other voltage on this pin
	PULSE	X axis pulse signal	Output voltage $\geq 3V$; Drive current $\leq 8mA$	
	DIR	X axis direction signal	Output voltage $\geq 3V$; Drive current $\leq 8mA$	
	SHIELD	Shielded signal	shielding wire of X axis driver output signal	Do not impose other voltage
Y_AXIS	5V	Y common anode	Common anode power supply of Y axis driver provides 5V output	Do not impose other voltage on this pin
	PULSE	Y axis pulse signal	Output voltage $\geq 3V$; Drive current $\leq 8mA$	
	DIR	Y axis direction signal	Output voltage $\geq 3V$; Drive current $\leq 8mA$	
	SHIELD	Shielded signal	shielding wire of Y axis driver output signal	Do not impose other voltage
Z_AXIS	5V	Z common anode	Common anode power supply of Z axis driver provides 5V output	Do not impose other voltage on this pin
	PULSE	Z axis pulse signal	Output voltage $\geq 3V$; Drive current $\leq 8mA$	
	DIR	Z axis direction signal	Output voltage $\geq 3V$; Drive current $\leq 8mA$	
	SHIELD	Shielded signal	shielding wire of Z axis driver output signal	Do not impose other voltage
C_AXIS	5V	Y common anode	Common anode power supply of Y axis driver provides 5V output	Do not impose other voltage on this pin
	PULSE	Y axis pulse signal	Output voltage $\geq 3V$; Drive current $\leq 8mA$	
	DIR	Y axis direction signal	Output voltage $\geq 3V$; Drive current $\leq 8mA$	

	SHIELD	Shielded signal	shielding wire of Y axis driver output signal	Do not impose other voltage
Port label	Port definition	Signal description	Pin functions and parameters	Notes
OUTPUT SIGNAL	Y01	FWD/REV	Logic low	If the inverter has been connected to FWD and DCM, no need to connect to Y01 port
	Y02	Multi-Speed 1	Logic low	
	Y03	Multi-Speed 2	Logic low	
	Y04	Multi-Speed 3	Logic low	
	Y05	Alarm indicator	Logic low	
	Y06	Run indicator	Logic low	
	Y07	defnable	Logic low	
	Y08	defnable	Logic low	
	24V	Output DC 24V	Output 24V	Supply DC24V for indicators
	GND	GND		
	SHIELD	Shielded signal		
INPUT SIGNAL	X01	X Machine zero	Logic low	支持机械、接近、光电等类型开关
	X02	Y Machine zero	Logic low	支持机械、接近、光电等类型开关
	X03	Z Machine zero	Logic low	支持机械、接近、光电等类型开关
	X04	Tool setting	Logic low	支持普通对刀块和对刀仪
	X05	Driver alarm	Logic low	
	X06	Hard limit	Logic low	
	X07	E-stop	Logic low	
	X08	Pedal switch	Logic low	Pause during processing&repe at after processing
	24V	Output DC 24V	Provide 24V working voltage	Offer for active sensors
	GND	GND	Provide ground signal	Offer for active sensors
	SHIELD	Shielded signal		

3.3 Hardware wiring

Installation Requirements: Switching mode power supply (24V, 3A) , it's better to add a filter to prevent the electric field interference. If origin detecting switch is different power supply type, the special detecting switch power supply is needed. (Recommend 24V origin detecting switch).

RichAuto motion control system realizes its control through the connection between the interface board and CNC machine. Interface board terminal can be divided into input terminal and output terminal:

Input terminals: INPUT SIGNAL terminal; Main power supply terminal.

Output terminals: X,Y,Z,C axis pulse signal output terminal; OUTPUT SIGNAL terminal.

Input terminal

➤ Main power supply wiring:

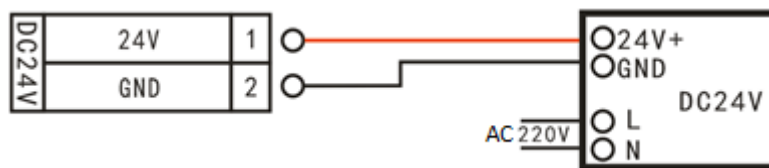

➤ INPUT terminal wiring:

- 1) **ZERO point (HOME):** X, Y Z axis wiring methods are the same

Mechanical switch

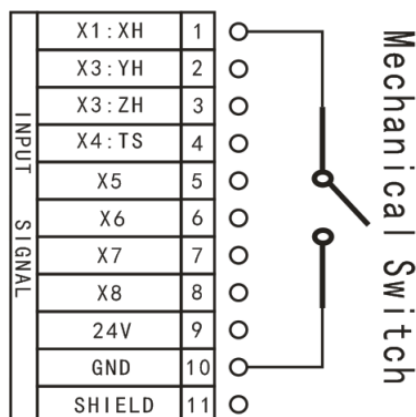

NPN normally open proximity switch

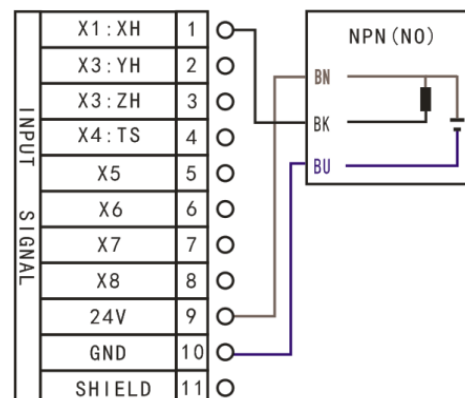

Wiring example of PNP normally open proximity switch:

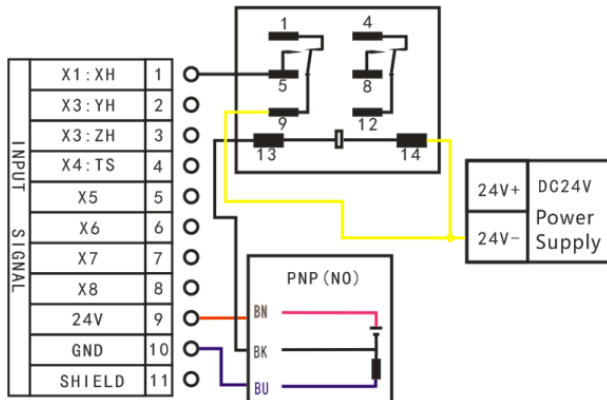

2) Tool setting: Simple constructed cutter touch-off plate

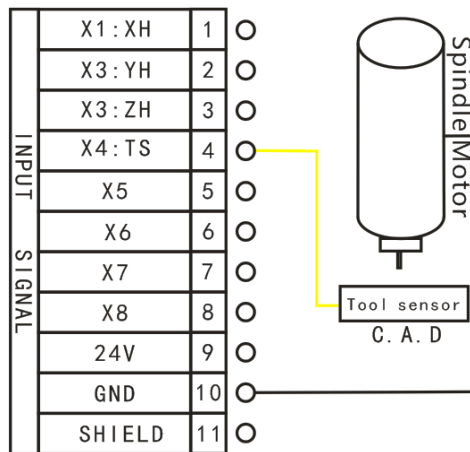

3) X5-X8: Default low level normally open

Take the driver alarm as example:

The alarm signal is normally closed, wiring method is series connection. Meanwhile, revise the voltage definition of X5.

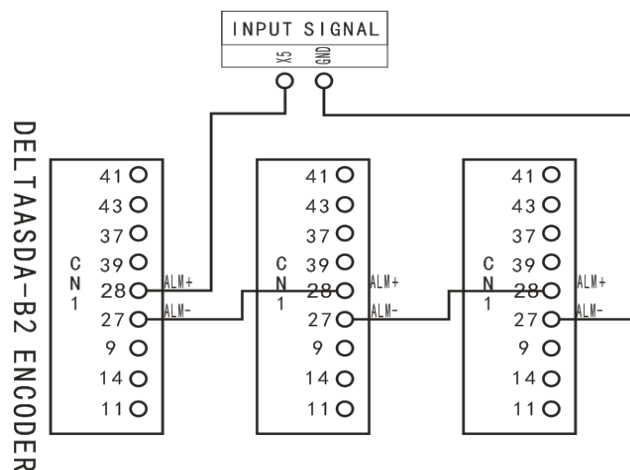

If the alarm signal is normally open, the wiring method is parallel connection. See as below,

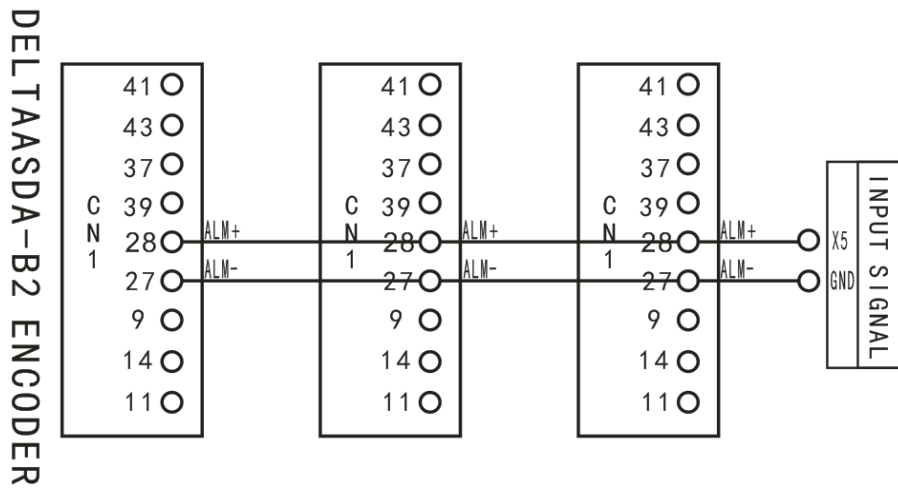

Output terminals:

- 1) X axis pulse signal wiring (Y, Z axis pulse signal wiring is the same to X axis)

Step drive:

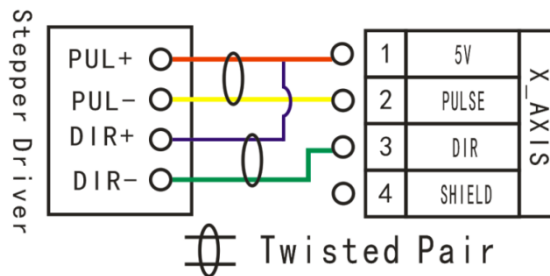

Servo drive: Σ -7 and Σ -V are the same wiring method

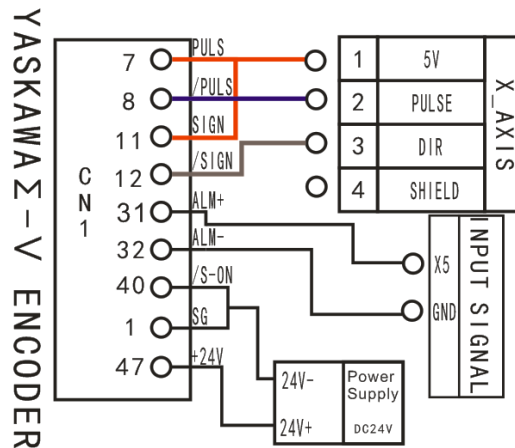

Brake wiring:

Yaskawa servo Σ -V series driver

参数	连接器针端子		含义	生效时间	类别	
	+端子	-端子				
Pn50F	n. □0□□	-	-	不使用 /BK 信号 [出厂设定]。	再次接通电源后	设定
	n. □1□□	CN1-25	CN1-26	从 CN1-25/CN1-26 输出 /BK 信号。		
	n. □2□□	CN1-27	CN1-28	从 CN1-27/CN1-28 输出 /BK 信号。		
	n. □3□□	CN1-29	CN1-30	从 CN1-29/CN1-30 输出 /BK 信号。		

First, ensure that the brake output is enabled, and then set Pn50F to 0300, and select brake signal output terminal CN-29 and CN-30. Wiring is as follow,

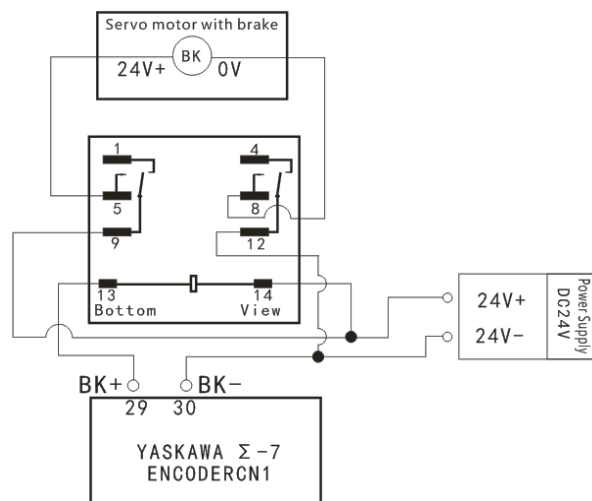

2) Spindle output

3 line 8 speed-1

3 line 8 speed-2

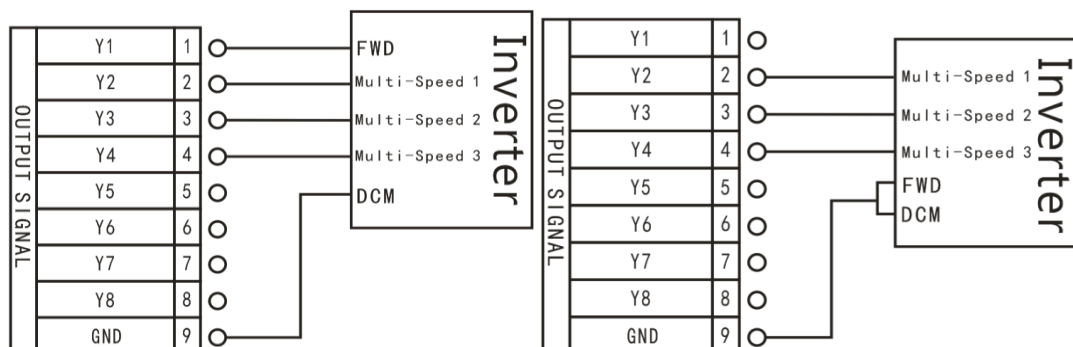

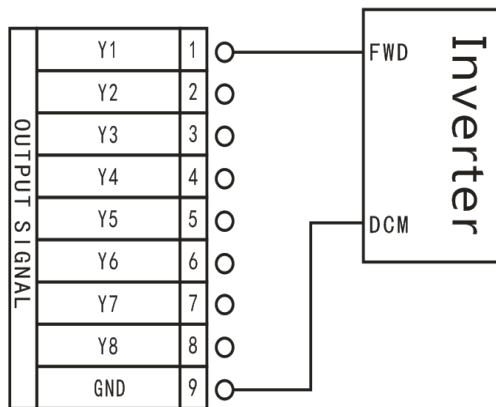
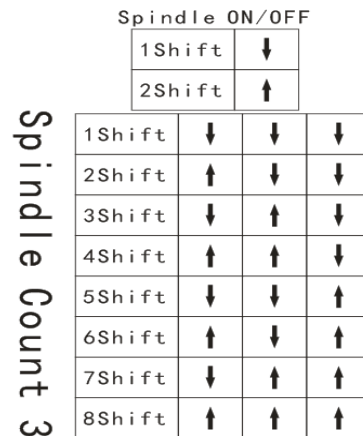
1 line 2 speed (ON/OFF)

Spindle state setting

Note: S1-S8 are corresponding to 8 different spindle speed; While the spindle is stopped, the screen displays Fn (n stands for shift number 1 to 8), it is the spindle speed when spindle stop.

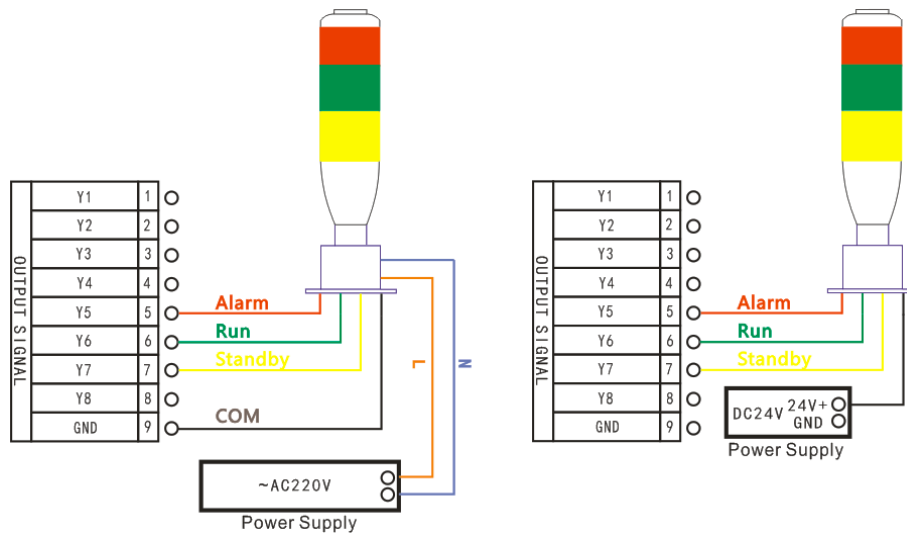
The user no need to set spindle state, only have to input the actual line number, because the system corresponding shifts automatically.

3) OUTPUT SIGNAL Y5-Y7

The system can start work when the above connectings are completed.

3.4 Commissioning of machine tool and control system

- 1) After turn on the power, manually move each axis and confirm the direction. If the movement direction and definition direction are opposite, should change the motor phase sequence (A+,A- or B+, B-) or modify the servo driver parameters (this could refer to servo driver manual).
- 2) According to the defined position of machine origin coordinate, enter into MENU – machine setup- Home setup- Home direction to set HOME direction.



- 3) Double press “” to enter into manual voltage setup (the upper arrows stand for input voltage) to check whether the home switch is working properly (manually trigger, arrow flip) or not.

You can determine the machine has been properly connected if none of above operations failed.

4 MENU description

4.1 Menu category

RichAuto-B11 motion control system manages the menu according to its function type, as shown below,

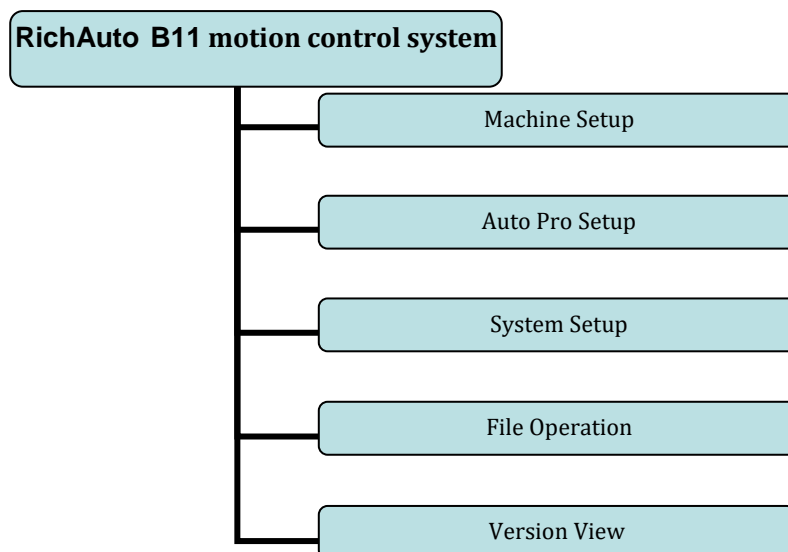

4.2 Menu details

4.2.1 Machine Setup

The menu “Machine Setup” is used to set machine hardware related parameters. It is set by machine producer according to equipment type. No need to modify if the machine hardware or electrical parameters have not changed; If user needs to change the setting, shall consult the equipment manufacturer and modify it under the guidance of the technical engineer.

Menu structure of Machine Setup

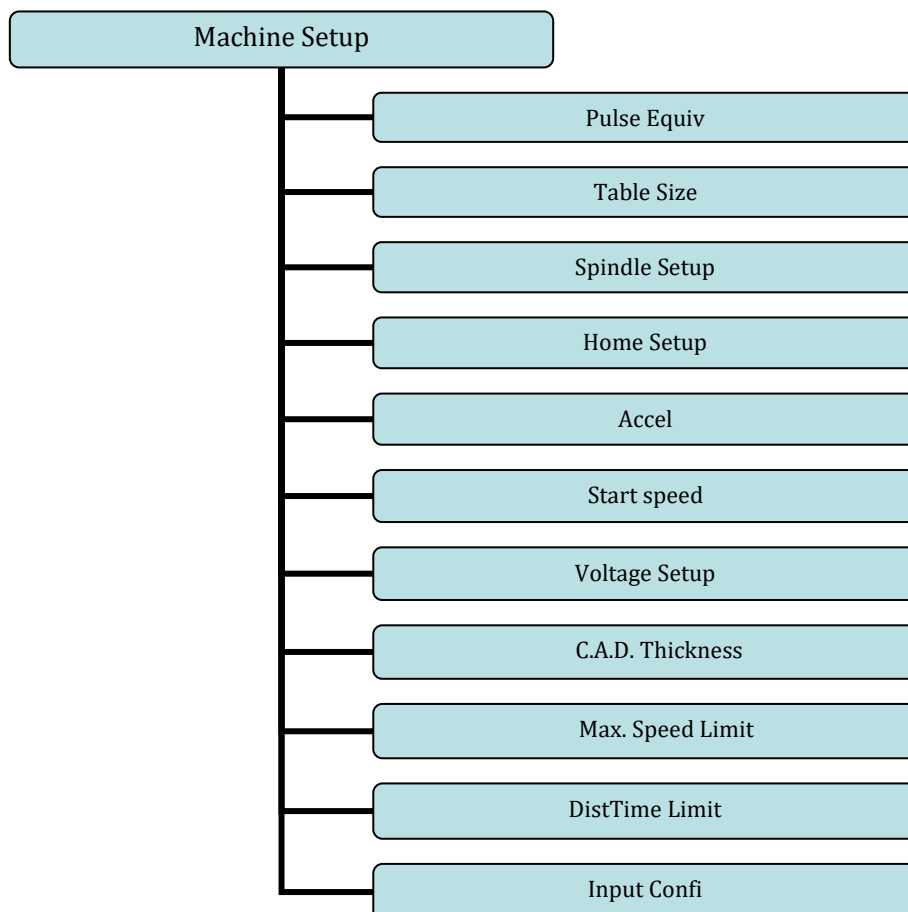

Pulse Equivalent

Linear axis: The number of pulses required to send from the system when machine moves every 1mm. Unit: pulse / mm;

Rotating axis: The number of pulses required to send from the system when machine rotate every 1 degree. Unit: pulse / degree.

Calculation methods please refer to chapter *SP5*.

Setting mode: Enter "Pulse Equiv", cursor is in the X axis pulse equivalent position,

press "X+ 1" or "X- 5" to move cursor as required. Press "RUN/PAUSE DELETE" then, input a new

value, and press "ORIGIN OK" to save. To modify X, Y and Z axis value one by one in the same way. Save all changes and return to the "Pulse Equivalent" menu.

Table size

RichAuto system makes the table size as the soft limit values, in order to prevent machine over travel. Machine size must be less than or equal to the actual size of machine table.

Setting: Enter "Table Size", press "X+ 1" or "X- 5" to move cursor as required. Press

"RUN/PAUSE DELETE" and input the new value, press "ORIGIN OK" to save the changes. To modify X, Y and Z axis value one by one in the same way. Save all changes and go back to the "Table size" menu.

Spindle Setup

Spindle delay: Including start delay and stop delay(Unit: ms).

Spindle state: To be used to set multi-speed control or simply spindle on/off signal control parameters. System defaults "3-line8-state", if user needs "1-line2-state (On/Off)", just change the number of lines to 1; See detailed settings at OUTPUT SIGNAL spindle output wiring.

Home Setup

Home speed: The movement speed of each axis when go mechanical origin (ZERO), the system default X, Y axis home speed: 3000 mm/minute, Z axis home speed: 1800 mm/minute.

Home order: Motion sequence of each axis when executing return ZERO (return mechanical origin).

Including:

Z, X and Y	Z, X, Y	Z, Y, X
Z only	XYZ home	X and Y, Z
X, Y, Z	Y, X, Z	XY home
X, Y home	Y, X home	None home
X home only	XZ and Y	

Home direction: Movement direction of each axis when return ZERO. The directions are depending on the real assembly position of HOME switches on the machine tool. If home switch is installed in the positive movement direction, then home direction should set as “Positive”, if it is installed in the negative movement direction, the home direction shall set as “Negative”.

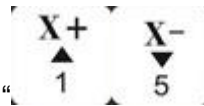

Setting mode: Enter “**Home direction**”, press “**1**” and move cursor as

required. Press “**DELETE**” to change home direction, then press “**ORIGIN OK**” to save the changes. Return to “**Home direction**” menu.

Acceleration (Unit: mm/s²)

The maximum acceleration value during acceleration and deceleration movement, improve (including straight and curved motion) processing capabilities. If acceleration value is too big, it may cause the motor losing steps, tremble and even squeak; Setting value too small, will cut down the operating speed of the entire graph.

System default: linear acceleration is 800 mm/s², curve acceleration is 1000mm/s², the proposed curve acceleration is 1-1.5 times of the linear acceleration value.

Start Speed (Unit: mm/min)

Start speed of motion axis from stationary state. Not starting from 0, but starting directly from a certain speed, so it can shorten the overall processing time, but this speed shouldn't be too high. Too high, it will cause the motor losing steps, jitter and even whistle; Set too small, it will reduce the operating speed of the entire graph.

If the inertia of motion axes is heavy (shaft very heavy), can set a smaller starts peed; if the inertia of motion axes is light (shaft very light), can increase the start speed value.

Voltage Setup

Used to set the input, output signal port normally open or normally closed port state, system defines “↓” as normal open; “↑” as normal closed.

Including 2 rows of arrows:

The upper arrows indicate the input level definition: Set input signal terminal status definition.

The first four: **0,1,2,3** are **X** axis HOME, **Y** axis HOME, **Z** axis HOME, tool setting signal; The 5 to 8 positions are: **4,5,6,7** correspond driver alarm, hard limit, E-stop signal and foot switch input signals.

The under arrows indicate the output level definition: Set output signal terminal status definition.

The top four: 0 1 2 3 correspond to **spindle On/Off**, **multi-speed 1**, **multi-speed 2**, **multi-speed 3** output signals; The 5 to 6 positions are: 4, 5 correspond **alarm lamp**, **run lamp** output signals.

	X1	X2	X3	X4	X5	X6	X7	X8
Input level	0	1	2	3	4	5	6	7
	↓	↓	↓	↓	↓	↓	↓	↓
Output level	0	1	2	3	4	5	6	7
	↓	↓	↓	↓	↓	↓	↓	↓
	Y1	Y2	Y3	Y4	Y5	Y6	Y7	Y8

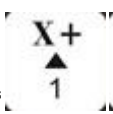
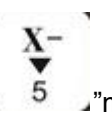
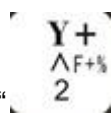
Setting: Press “ ” move to left or right in the row. Press “

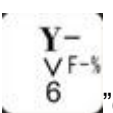
” can jump up and down. Move the cursor to arrow which needs flip, and press

“” to flip the arrow.

C.A.D. Thickness (Unit: mm)

The thickness should input actual value. If the input value is bigger than the actual thickness, Z axis may over cut; if smaller, Z axis tool bit can't reach workpiece surface. This parameter can only take effect when user uses auto tool setting function. Invalid when manual set workpiece origin (press XY→0, Z→0)

Max Spd Limit (Unit: mm/min)

Set the maximum movement speed of three axis positive and negative direction, the setting is only effect during processing, not affect the speed in manual mode;

System defaults max. speed X+/-,Y+/-are 60000000 mm/min, Z+ is 1800mm/min, Z- is 3000 mm/min.

Distance Time Limit (Unit: s)

When the Distance mode was selected, it will automatically switch back to Continuous movement mode if there is no action for a certain time of period. To avoid the spindle hits against the machine body (Under this circumstance, such as the user have set a big Distance value and forgot to switch back to Continuous mode). The systems default Distance mode limit time is 30s.

Input Confi (Input Configuration)

Enable or disable the input port. User can disable X5-X8 if there is no signal on these ports.

4.2.2 Auto Pro Setup

The menu "Auto Pro Setup" is used to set parameters of processing file and G code file reading properties.

Menu structure of Auto Pro Setup

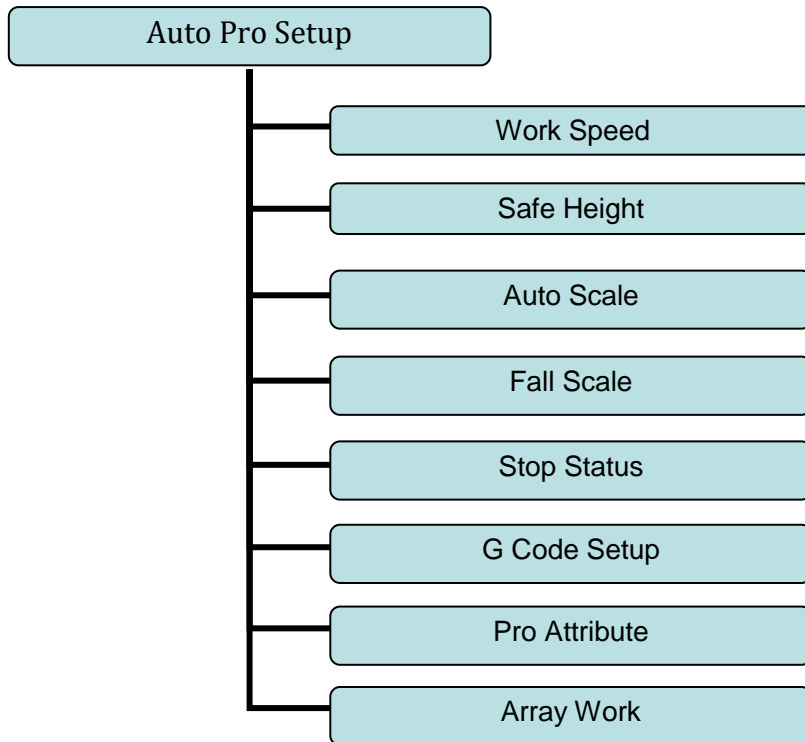

Work Speed (Unit: mm/min)

Including work speed and fast speed, system default is 3000 mm/minute.

Safe Height (Unit: mm)

Z axis lifting height during processing. System default is 40.000mm.

Auto Scale

Actual processing speed=work speed*auto scale. System default the auto scale doesn't affect the fast speed.

Fall Scale

System default the fall down scale is 0.200, Fall speed=fast speed*fall scale, the maximum fall speed is Z- axis limit speed*fall scale.



Fall height, system default is 5.000mm. Fall down scale takes effect when the spindle falls to the fall height.

Stop Statue

Stop position when the processing is finished. You can set either a special location or system specified location.

Work stop state	
FinAct	Pick up Z
XCoordnt	0.000
YCoordnt	0.000

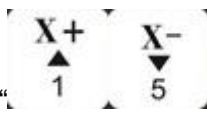

(FinAct=Final Action; Coordnt=coordinate)

- 1) Set a special stop position: Press “” move cursor to where user wants to modify. Press “”, input new coordinate values one by one, then press “” to save the changes.

- 2) Set system specified location: Move the cursor to the first row, and press “” to enter into system final position list:

FinAct
Pickup Z
Back To Work Org
Back Home

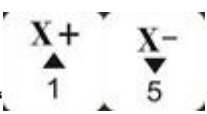
(FinAct=Finish Action, Org=Origin)

- Press “” to move cursor to where user wants to modify, then press “” to save the change. Return to the upper menu.



G Code Setup

Set special G code attribute, according to the actual need to make changes.

Attribute Of G Code	
F Read	Ign F/Read F
AbsCntr	Off/On
T Read	Ign T/ Read T
Spindle	NTLLG/FORCE/INSTR
FilterJD	None/ Adj Z Filter
S Read	Ign S/ Read S
Read G54	Ign G54/ Read G54
Read G49	Ign G49/ Read G49
Read G40	Ign G40/ Read G40
CodeHead	Skip/NoSkip
Input TO	-1

(Ign=Ignore, Adj=Adj=Adjust, AbsCntr= Absolute center)

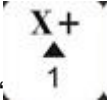
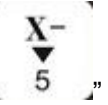
PS: Blue parts indicate system defaulted attributes.



Setting: Press “ ” move cursor to where needs to modify, press “”

and select, then press “” to save. Return to the upper menu.

Pro Attribute

Work attribute	
Adj Z	Adj Z/Rev Z
Adjust WP	None/Adjt
Ignore Z	Read Z/ Ign Z
CirLmt	55.556
StepWork	Contns/Single
ATC Spld	Auto/None

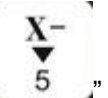
Set some special settings in the process, according to the actual need to change.

Setting: Press “ ” move cursor to where needs to modify, press “” and select, then press “” to save. Return to the upper menu.

Array work

Set array work parameters, including **column count**, **Row count**, **Column space**, **Row space**, **Time Interval** (unit: ms)

Column space: The space along X axis;

Row space: The space along Y axis;

Total Processing times= column count* Row count

Time Interval: System default 0, it means not wait.

During processing, if user wants to change processing materials after completion of each processing, needs to set time interval as a negative number.

When the first time processing is completed, the screen prompt “Waiting for the next array processing...” At this moment, user presses any key to start the next array processing, if user doesn't press any key, the system will keep waiting.

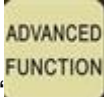
Starting array work, press “” the system prompts advanced processing list, and then choose the array work from it.

4.2.3 System setup

Menu structure of System Setup

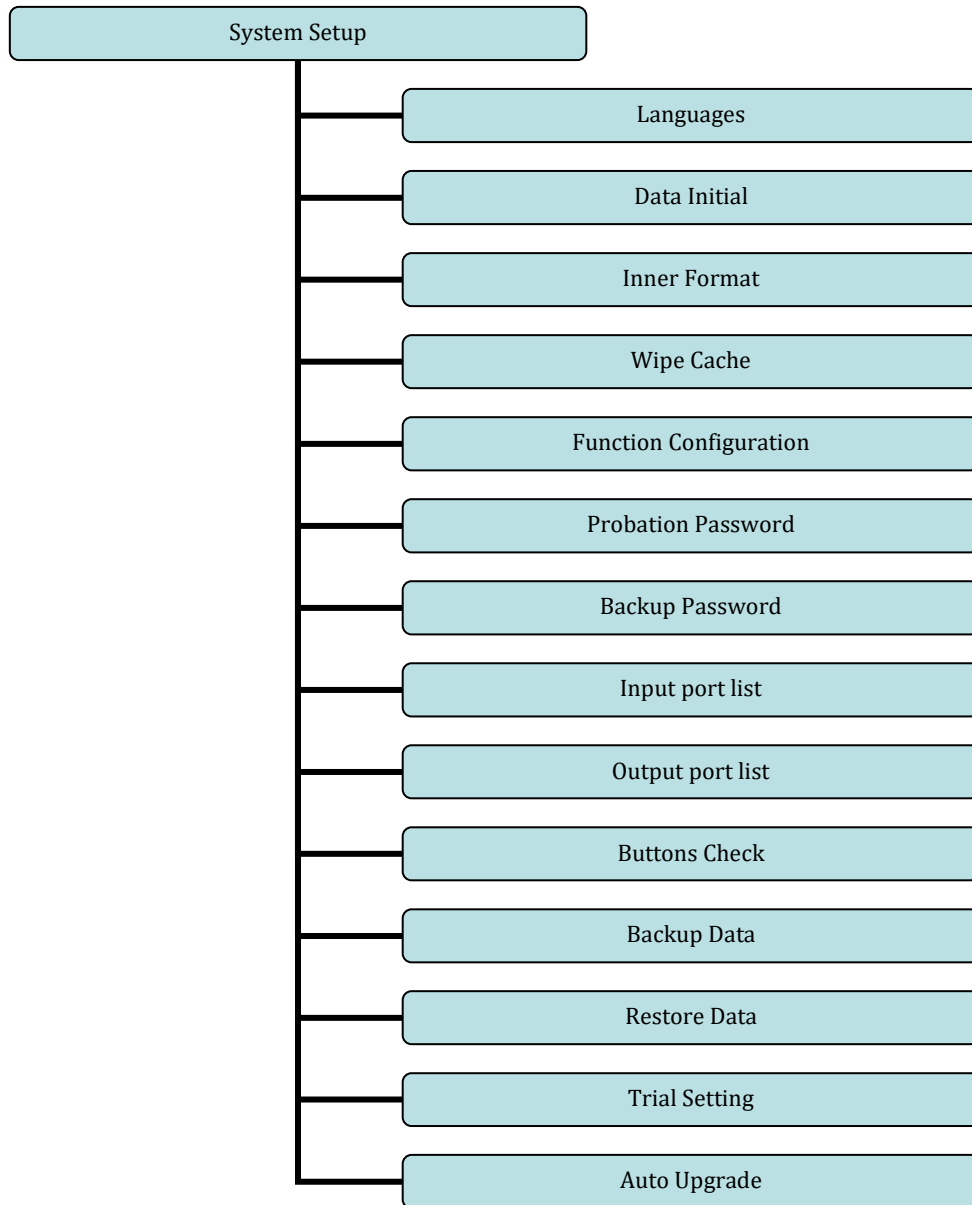

Languages

Change system display language, Chinese or English language.

Data Initial

After data initial system parameters will restore to factory setting

Inner Format

Wipe the internal files. It won't remove the system parameters after inner format.

Wipe Cache

The system needs wipe cache when it has been using for a long time or after the system upgrading, it will ask to reboot after “Wipe Cache” operation.



Function Configuration

Set whether the system retains a function or not, change it in accordance with the practical application needs. After the operation user needs to restart the handheld controller.

Set function	
PausePkup	NoPick/Pickup
ScaleFast	None/Affect
Manual	Step/Trad
Pretrt	Parse/None
QuryPara	Query/None
StrtHome	Query/Auto/ZOnly/None
CopyWork	Off/On
RetOrgPZ	Pick Z/Z Stop
TolstAct	Pickup/Origin
PauseRstr	All/only Z

PS: Blue parts indicate system default function.



Setting: Press “” and select the function in needs, then press “” to save the change. Return to the upper menu.

Probation Password

In case of the CNC machine manufacturer has set passwords before delivery (including trial password and backup password)but forget the password when the password expired, the user could inform RichAuto the original 20 digits password which displays on the system screen, and then get new 20 digits from us to input into the controller to unlock all passwords.



Setting: Press “” to enter into ‘Probation Password’, input new password directly



and then press “” to save.

Backup Password

In condition of system parameters are disordered, to avoid incorrect operation such as covering off the correct system parameters or backup parameters. Don't enter any



number when it asks to input password, then press “” if user wants to cancel the backup password.

Input Port List

To be used to review the current input port configuration.

Number 1 to 3 are X,Y,Z ZERO input signal; Number 4 is tool setting input signal; Number 5 to 7 are Driver alarm, Hard limit, E-stop signal, Foot switch(Cycle switch) input signal.

Output Port List

To be used to review the current output port configuration.

Number 1 is Spindle on/off output signal; Number 2-4 is Spindle shifts output signal; Number 5 is Alarm lamp output signal; Number 6 is Run lamp output signal.

Buttons Check

Detect the keys are valid or not. Press every button, the screen will highlight it if the key is



valid, if not valid will not highlight. Use combination keys “” + “” to exit.

Backup Data

Backup the system parameters and send to U disk or inner space. The backup file format is **data.bak**





Restore Data

Restore the backup system parameters by choosing the “**data.bak**” file from the U disk or internal storage area.

Trial setting

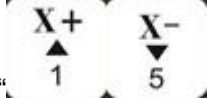
There are 4 grades of password (Level 1, level 2, level 3 and level 4). Each level can be set password and use time. User can set 1-8 digits; Using time unit is Hour and the system defaults use time is 1h.

When the previous password expires, the next level of password will come into effect. **The operation of Data Initial, Inner Format, Wipe cache and system upgrade are unable to remove 4-grade password.**

Setting: Press "" to access into "Trial setting" menu, press "" to move the cursor and select different options, then press "" to get into, press "" to input numbers and after finished to press "" to save the change. Then go to the next option...one by one. When completed all settings, press "" to confirm. The screen shows as follow:

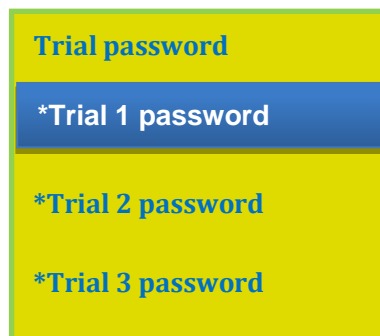

Only the punctuation '*' shows before each level of password indicates trial password has been set successfully. If the level doesn't have '*', the password will not work normally.

When the password is expires, the screen will display as below,

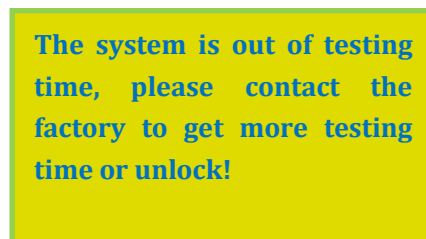

Contact the manufacturer to obtain the password, and press “” under this interface,

then input the new password directly then press “” to confirm. The screen will prompt as below,

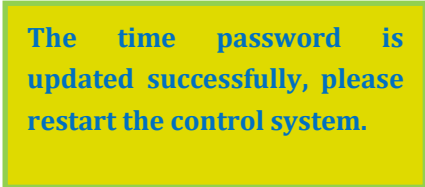

The time password is updated successfully, please restart the control system.

Restart the handheld controller, the system will work normally.

NOTE: If CNC machine manufacturers forgot all password, you can contact us and tell us 20-digit original password under “**System Setup--Probationpas**” menu, and then obtain new 20-digit

password from us, enter the new numbers and press “” to remove 4-grade password and reset them.

Auto Upgrade

If we added new functions, we will offer upgrade file which extension name is *******.PKG** format (File name is **rz-xxxx** or **q13-xxxx**). User can update the system through an U flash disk, for more details please see chapter *PS1*. System updating doesn't remove the controller original parameters.

Upgrade package format sample:

 B11三轴雕刻[3寸单色屏][USB1](q13-378).pkg

4.2.4 File operate

Menu structure of Operate File

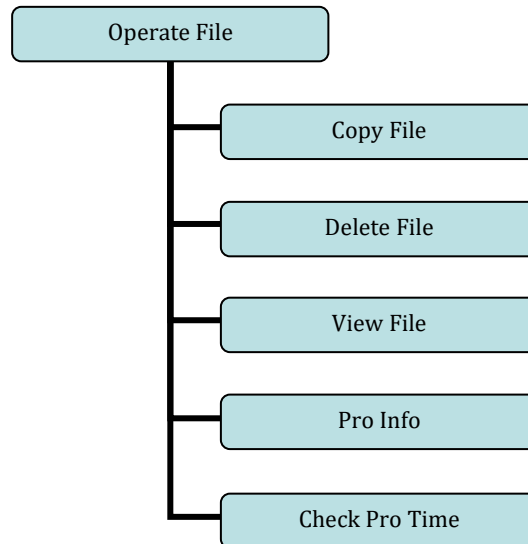

Copy file

Copy file from U disk to inner storage space.

Delete File

Delete inner file.

View File





View each line G code of the file which is in the U disk or inner storage space.

Pro Info (Processing Information)

Count the file completely processing number of times and time spent by file name. The record will be cleared when power off.

Check Pro Time (Check Processing Time)

Calculate processing time in accordance with the work speed. After reading G code, the screen will display the processing time.

Operate method: Press “” to enter into “Check Pro Time”, then press “” and select “U disk/ Internal/ Recent file”, press “” and then choose a file, press “”. After reading the G code, the screen will display the processing time.

NOTE: Please pull out the U disk correctly after copying files from computer, otherwise may cause the handheld controller doesn't recognize U disk.

Win7 (32 bit) system: after copying files, press “”, then the lower right corner of the screen will pop-up a dialog box “”, select Eject the corresponding U disk.

When you see this dialog box “” means the U disk has been removed safely from the computer.

Win XP system: after copying files, press “”, and click “”, then click “” to remove U disk successfully.

4.2.5 Version view

Users can view information about the system hardware and software, including:

- ✧ Update Version e.g.:P1.409/rz-xxxx/q13-802
- ✧ Product ID e.g.:A0020112
- ✧ Soft Version e.g.:A1.1936

- ✧ Emergency Version e.g.:A1.1920
- ✧ Soft type: 3-axis carving
- ✧ Hardware type: Support 3-inch screen Flash Disk Mode

5 Machine Tool Operation

5.1 HOME operation

It will display “**all axis home**”, “**Z home only**”, “**none axis home**” after starting up the DSP handle. Choose one among the options based on real needs. Machine return home can correct the coordinate of system. In some cases, such as after normal power off, reboot and continue last operation, no need to go machine ZERO, just choose “**none axis home**” to skip HOME operation. That is because system automatically saved coordinate values when it exited normally.

5.2 Import processing file

Before processing, generally we should import a file. RichAuto-B1X system has 2 ways to import file: U disk file processing, and inner file processing.

- 1) Import the processing file into U disk directly and then run with the U disk inserting in the controller.
- 2) Copy the file to handle internal storage area via a U disk, and then run the inner file without U disk inserting in.

5.3 Manual processing operation

Manual Processing Operation refers to move the machine tool by pressing the keypad. User can change the running speed and set the grid in manual mode. System will enter Manual Operation state after returned HOME, and the screen displays as shown below,

Manual control state initial interface:

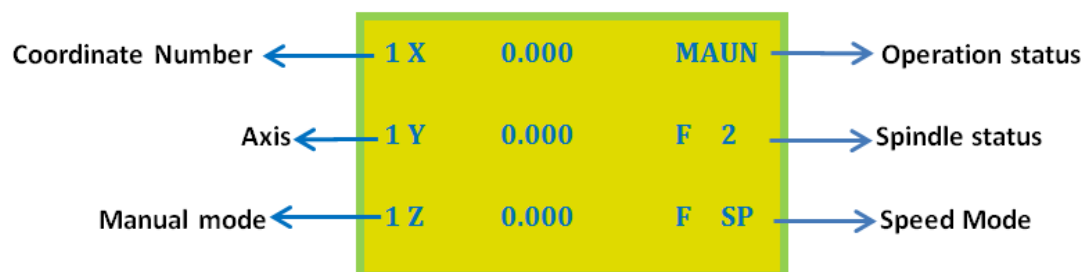

5.3.1 Manual speed switching and adjusting

- 1) Speed mode switching

There are 2 speed modes: High speed and low speed. We can switch speed mode by



pressing “0” key. The speed mode status show on screen determines the actual manual moving speed.

2) Speed adjusting

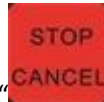

In manual mode, press “STOP CANCEL” enter into the current speed mode settings. For instance, suppose the current speed mode is LOW (screen shows ‘L’), the screen displays:

Manual Param	
X SLOW	1200.000
Y SLOW	1200.000
Z SLOW	1200.000



The cursor is on “X SLOW”, Press “X+ X-” to the one needs to be modified, and



press “DELETE” then input new value, and next press “ORIGIN OK” to confirm; Press



“STOP CANCEL” to exit the settings. If the input value is wrong, press “DELETE” delete the last number and then input new numbers.

To ensure the accuracy of processing and debugging, the system introduces the concept of ‘grid’ which also called ‘minimum feed rate’. Precision can reach to 0.001mm. When user switch to “step” mode, and press the direction keys of X, Y, Z axis, machine will move by grid distance.

High speed mode setting is the same to low speed mode.

5.3.2 Manual movement modes

The system provides 3 type of manual movement modes: Continue, step, distance. User



could press “” under manual mode to switch manual movement mode and view the current movement mode through the screen bottom display status.

- 1) Continue (Continuous motion mode)

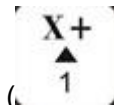

No specific data control, user could press motion direction key of each axis (

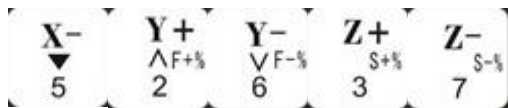

), the machine will move accordingly until the key is released. The motion speed is determined by current manual speed mode.

- 2) Step motion mode

In step mode, move 1 grid every half second. The grid distance is determined by the current speed mode. It is suitable for precise adjusting the cutter or fine adjusting the location of the mechanical coordinate.

- 3) Distance motion mode

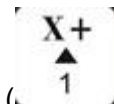

It runs a certain distance according to the setting. Press motion direction keys (

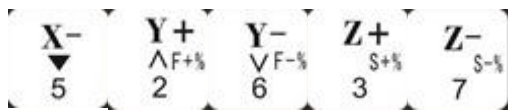

), the machine will move accordingly.

Note: The movement will be carried out according to the current speed mode and the set distance, it is not affect by the ‘grid’, so it will not stop on grid point. To change the



distance value, triple press “” re-enter the ‘Distance’ value setting.

5.3.3 Manual testing input & output

Under the initial boot interface, that is screen displays as follow,

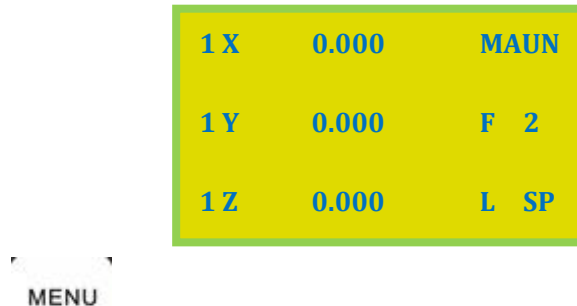

Double press “**↵**”, the screen will displays two rows of arrows which defaults all arrows are downwards “**↓**”.

Upper arrows represent input signals: the former 4 numbers 0, 1, 2, 3 corresponding to X zero, Y zero, Z zero and tool setting. The 4th,5th,6th are driver alarm, hard limit, emergency stop and foot switch (cycle switch) input signals.



Manual trigger the signal switch by pressing “**DELETE**”, the corresponding **arrow flip up indicates that the signal is normal**. If not, user should check its switch, wiring and 50 pins cable.

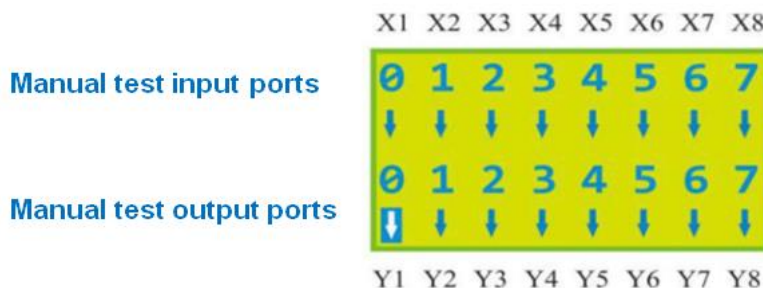

To trigger X1 (X axis HOME switch), the corresponding arrow will flip, means X1 signal is normal. X2 to X8 detecting is in the same way.

Note: Do not confuse with “Voltage setup”.





5.3.4 Manual switching coordinate system

Including machine coordinate system and work coordinate system.

Machine coordinate system is a fixed position, the origin point of machine coordinate is always a fixed position relative to the machine; its coordinate value is called mechanical values, the origin of coordinate is the origin of the machine or called reference point. So, at any time, a point in space can be uniquely determined by a mechanical coordinate system. Because of reference point is the calculation basis of machine coordinates movement, all of those operations such as power on the machine or abnormal release and so on have to return to the reference point which is refers to return machine ZERO.

Work coordinate system used more greatly than other coordinates system in processing. Usually, in processing, we describe a processing position is always relative to a certain point on the workpiece, whereas the workpiece on the machine tool's position relative to the mechanical origin is often change, so it is necessary to introduce a set of more convenient coordinate system during processing, that is work coordinate system. The origin of work coordinate system is a fixed point relative to the workpiece, but it is floating relative to the machine coordinate origin.

RichAuto-B11 provides 1 machine coordinate system and 9 work coordinate systems.

Press “ - ” can switch the machine coordinate system and work coordinate system; press “ - ” can switch among different work coordinate systems.

Schematic diagram of coordinate system:

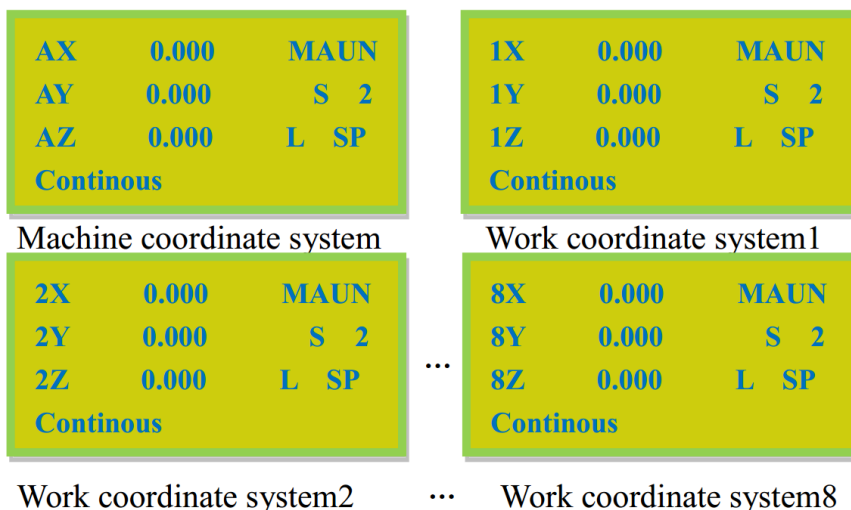

Note: The system cannot set workpiece origin under machine coordinate system. User should switch to work coordinate first, and then set workpiece origin.

5.4 Auto processing operation

Auto processing refers to the system runs according to the instruction of the file in U disk or inner storage space; it also called “file processing”. Before auto processing, user must set the machine tool parameters and all of the system parameters correctly.

Auto processing steps could refer to the following text.

5.4.1 Set work origin

The origin coordinates of X, Y and Z axis in the processing program is workpiece origin. Before processing, we should pay attention to this position as well as the real position. Operation is as follow:

Move X, Y and Z to the position which will start to process the file on workpiece.

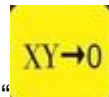

Afterwards, press zero clearing “” can set the workpiece origin of X, Y axis. Press

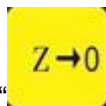

zero clearing “” can set the origin of Z axis. It should be noted that if user have



already used the automatically tool setting function which combination keys are “ - ”

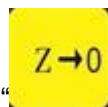







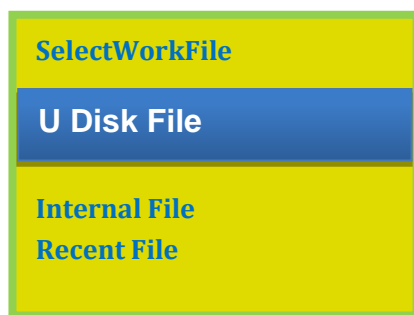

+ “” will no need to press “”.

5.4.2 Select processing file



After determined the workpiece origin, press “”, the screen shows:









Press “ ” move the cursor and choose, press “” to enter into the list, the screen will display the first three file names, press “ ” to move one by one; press “ ” jump 2 lines to move the cursor; press “” to exit.

5.4.3 Set processing parameters

After selecting object file, press “”, the user can modify processing parameters, including “work speed”, “fast speed”, “speed scale” and “fall down(scale)”.

Set Work Param	
WorkSpd	3000.000
FastSpd	3000.000
SpdScale	1.000

Press “ ” move cursor to select different settings, press “” input values and then press “” to confirm the changes. The system starts to check the codes and machine starts to process when the system finished the checking. The G code checking is system smart check mode, press “” to stop the code checking and directly access to automatic processing. System will remember the checking result only when it is a complete and correct checking. And the system will not check the same file again after complete and correct checking.

During the processing, system screen scrolling display real-time processing speed, operation time, and current line number. Switching those options by pressing “”.

5.5 Operations during processing

5.5.1 Speed ratio& spindle state adjusting

1) Speed ratio adjusting

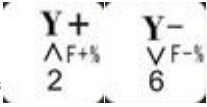
During processing, press “” adjust the speed ratio. The speed ratio

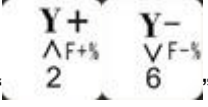
increase/decrease 0.1 each press on “”. Speed scale (speed ratio): max. 1.0; min.0.1, speed values are also change accordingly except for the time. Current processing speed = work speed * speed scale

2) Adjust spindle state

If user has set multistep speed, the DSP handle can change the multistep speed

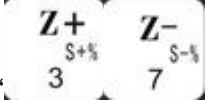
during processing. Press “” to change spindle speed from S1 to S8.

5.5.2 Pause & position adjustment

Press “” pause processing. The top right corner of screen will change from “MAUN” to “PAUS” and machine suspends processing except the rotating of spindle. Shown below:

1X	7.000	PAUS
1Y	8.000	S2
1Z	-2.000	F SP

At this moment, the user is allowed to adjust the position of X, Y and Z axis. The system default motion mode is **STEP**. So that user can fine adjust each axis distance. Machine moves one low or high speed grid distance every step. Meanwhile user can change the



speed mode to high mode just press “0”.



When the adjustment is finished, press “DELETE” again, screen shows:

1X	7.200	PAUS
1Y	41.300	S2
1Z	-2.000	H SP

The system asks the operator to confirm whether to save the modified position or not.



Press “OK” or “DELETE” key, the system will start processing at modified position;



Press “CANCEL”, the system will go back to the suspend position (before modifying).

5.5.3 Break work & power failure protection

1) Breakpoint processing



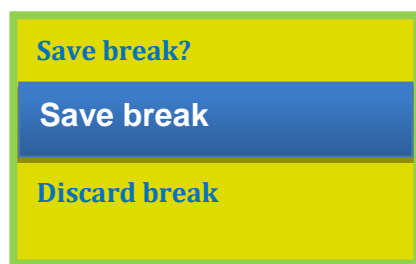

If user press “CANCEL” during machine running, the controller screen shows as below,



If you want to save the current machine location Press “”, the screen displays



break list (From breakpoint 1 to 8), press “” move the cursor and select,

and then press “” to save, system automatically move to workpiece origin. If the user needs continue processing from the breakpoint, could press the shortcut

key “”, the system will restore the machining from corresponding breakpoint.

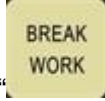

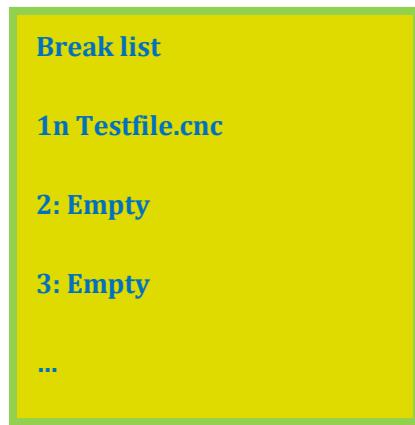
E.g.: To restore from breakpoint 1, could press shortcut key “”, the screen shows the file name of on breakpoint 1 as below,

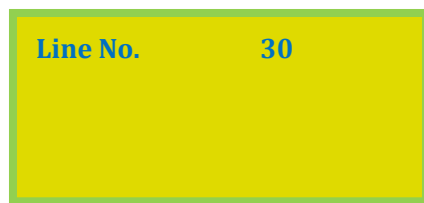

The G code file “Testfile.cnc” for example, it has totally 6705 lines g codes. Press

“” the screen displays breakpoint line No. after pre-reading.



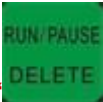

Press “” popup machining parameters list, then revise as needed and press “”, the system will resume processing from breakpoint 1. However, if user needs to go backwards from this breakpoint, shall press “”, then the screen shows as below,

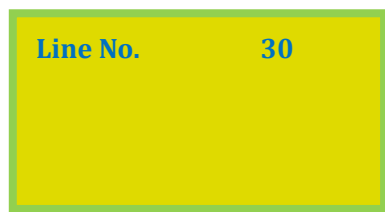

Input line number that required to return to, and then press “”, the screen will shows new line number as below,



Press “” popup machining parameters list, then revise as needed and press “” the system will start from the new line. The system must have an action of returning HOME (machine origin) during the period of saving breakpoint and before machining.

2) Power off protection

When there is a sudden power failure during processing, system will save current coordinate and parameters, while power restart, process continues. Before that, system must have a HOME motion. Shown as below,

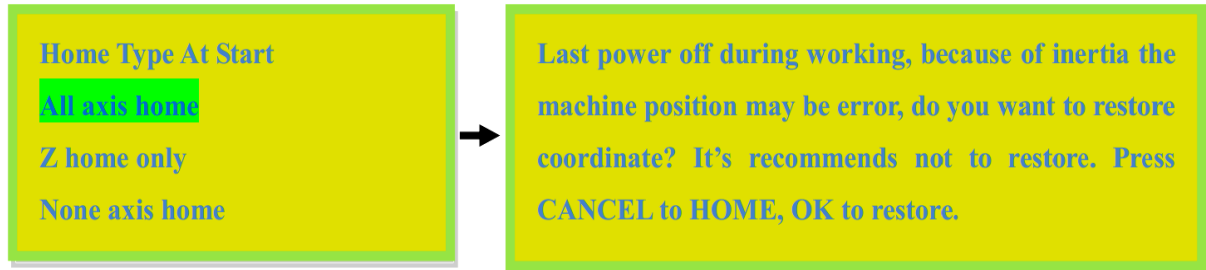

Press "" key to start processing the unfinished process, it will display stop line no.,

and the line no. also can be chosen. Press "" cancel the power off protection. *If here the user wants to go backwards from current position, the operate method is the same to what has mentioned in breakpoint processing.*

5.6 Advanced work

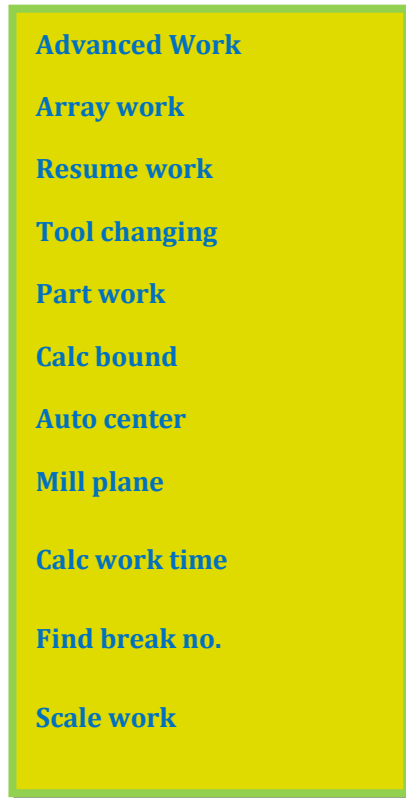

Advanced processing is designed for some special requests, it contains: **Array work**, **Resume work** (breakpoint processing), **Tool changing** (manual change tool bit), **Part work**, **Calculate bound**, **Mill plane**, **Calculate work time**, **Find break No.**, and **Scale**

work. The shortcut key is "". When the advanced Work is enabled, the screen show as below,

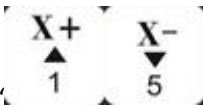

5.6.1 Array work

Steps as below:

1) Press " " to move cursor to the Array work, press " "to enter, and

then press " " again to select different listed files;

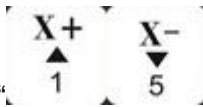
2) Press " " to enter file list, then press " " to move the cursor to choose target file;

3) Set machining parameters, revise array parameters, or go to "MENU"--"AUTO PRO SETUP", choose "Work Array" and modify the array parameters. The rest steps are similar to the normal processing. After that, system will start the array work according to the user's settings.





4) During array work, press “” view real-time row number, column number and other processing information.

Note: If user needs to manual control in array work, just change the setting of “Interval (unit:ms)” into a negative number.

5.6.2 Resume work

Steps as below:



Press “” to move cursor to resume work, press “” to enter the breakpoint list, then move the cursor to the breakpoint position as needed, press



“”, the system will resume work from the chosen breakpoint. *If you want to return*



back towards from the breakpoint position, should press “” to input new line





number and then press “”, system will start processing from the new line. For specification operation steps can review the contents in 5.5.3 Break work & power failure protection.

5.6.3 Tool changing

It means manually loading or unloading the cutting tool in a certain position of the machine









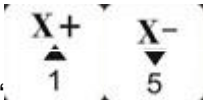

tool. Press “” to get into the setup, after changing the tool bit press “” to move back to the previous location.

5.6.4 Part work

Part work means user can select a start line and stop line from G code, which can realize machining a part of G codes from the processing file. The operate steps are as follows:

1) Press " " to enter the setup, press " " to move the cursor and select a file and wait for the file reading process;





2) Press " " when the system ask to input start line no. and stop line no..Then the screen displays codes of the first line. Press " ", screen shows: input new line no.(and also shows the total lines count of the file). Input the start line number at the cursor and press " " to confirm. If the input value is wrong, could press " " key and revise before confirm.

3) Once more press " "to set the end line number, it will prompt: **Input end line number.** Press " " the screen will show the modified start line number, so here press " " key, input an end line number and press " " to save it. If the input value is wrong, could press " " key and revise before confirm.

4) Set processing parameters. The rest steps are consistent with the common processing.

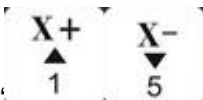
5.6.5 Calculate bound

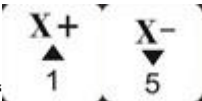
Calculate bound means user can check the size of processing, So as to avoid unnecessary waste of materials and machining errors. The steps are as below:

1) Press " " to move the cursor to "calculate bound", press " " to access in it. Then press " " to select a file and press " ";

2) Waiting for system file reading, and show the calculate result of file size.

5.6.6 Mill plane

Including two types: Scan milling and Encircle milling

a. Scan milling

Scan mill set	
ScanType	X Scan
Width	100.000
Height	100.000
Diameter	10.000
Depth	0.00000
Z Step	0.100
T Ratio	0.800

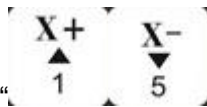

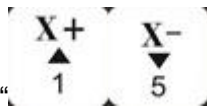
1) Press “” to move the cursor and choose “scan mill”.



2) Press “” to enter into the “scan mill set”, it contains parameters: **Scan type**, **(Scan) width**, **(Scan) height**, **(Tool bit) diameter**, **(Scan) depth**, **Z Step**(Z feed amount), **T Ratio**(feed ratio);

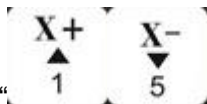

3) Press “” to move the cursor and press “” to modify parameters,



press “” to save all the changes.

b. Encircle milling

Scan mill set	
ScanType	
AC(anticlockwise)	
Width	100.000
Height	100.000
Diameter	10.000
Depth	0.00000
Z Step	0.100
T Ratio	0.800

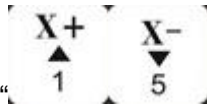

- 1) Press “ ” to move cursor to choose the mill type as “Encircle milling”.



- 2) Press “ ” to enter the “scan mill set”, it includes: Scan type, Scan Width, Scan Height, Cutter Tool Diameter, Scan Depth, Z Step and T Ratio.

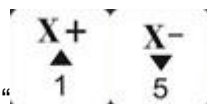

- 3) Press “ ” to move the cursor and press “ ” to select scan type

(**anticlockwise or C.W.**) and modify parameters, press “ ” to save all the changes.

5.6.7 Calculate work time

Calculate the total processing time according to the system “work speed”. After reading the processing file, the screen displays processing time, different work speed correspond to different processing time.

5.6.8 Find break no.

During processing, if accidentally tool damaged and user hasn't saved the break point, stop working and replace cutter tool. After that, user can manually move X, Y axis to the nearest point where the cutter was broken (recommend to move a little further), press



“DELETE”+“0” to start advanced work, move cursor to “Find break no.”, then press



“ORIGIN OK” to enter in. After guide and reading code, the system prompts:

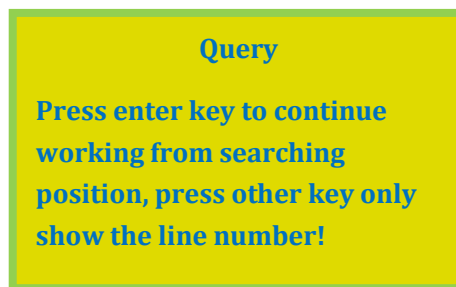

Press “REF OK” to start processing, press “CANCEL” key, the screen shows the current position line number as below:

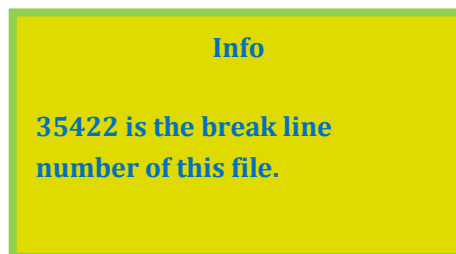

Note: When using the “find break no.” function, must at the same work coordinate system.

5.6.9 Scale work

If the actual processing requires different sizes of the same file, user can use “scale work”, and enter a zoom in/out ratio.



Steps: Press “ORIGIN OK” to get into “Scale work”:

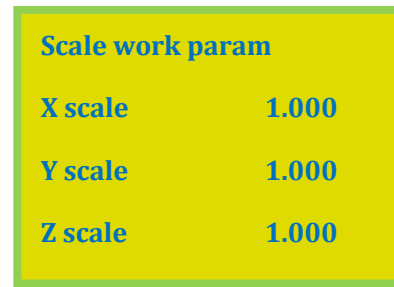
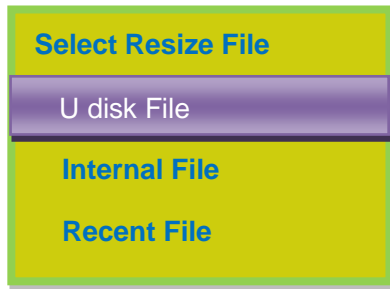

After changing all the value, user could start the “scale work” machining.

PS1 System upgrade operation



During using, system software may have updated version which can upgrade the handheld controller, operation as follow:

Upgrade with **.PKG file from U disk

Way 1:

Store the **.PKG file (Upgrade package) into U disk, and insert the U disk in the top right port on handheld controller. The upgrade pack name in the controller is rz-xxxx or qxx-xxx.



Press “”, select “System Setup” and press “”. Move the cursor and choose “Auto upgrade”. The screen shows as follow,

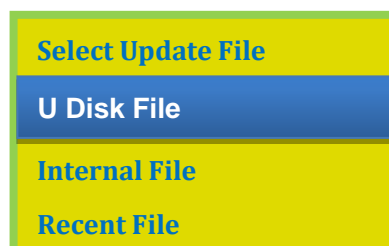

Choose “U disk file” and press “” to access in U disk storage area and select



relative upgrade pack then press “”, the system will complete the updating automatically.



When the upgrading is successful, user should restart the controller.

Way 2:

Store the **.PKG file (Upgrade package) into U disk, and insert the U disk in the top right port on handheld controller. The upgrade pack name in the controller is rz-xxxx or qxx-xxx.

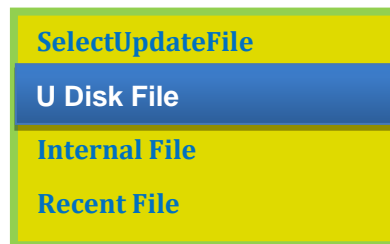
press “” + “”, the screen shows:





- 1) Choose “U disk file” and press “” to access in U disk storage area and select relative upgrade pack then press “”, the system will complete the updating automatically.
- 2) When the upgrading is successful, user should restart the controller.

PS2 “Flash disk mode” function introduction

RichAuto adds “Flash disk mode” to A1X and B1X which hardware number start from **A010**** (E.g.: A0101203)**, & **Update Version from rz-1967 (the system needs to update if the update version number lower than 1967)**. Connect handle and computer by USB cable, find portable storage device on the computer, and then copy processing files from computer to handle inner. This function can ensure that if USB port of the handle is broken or there is no U disk, the machine can still work normally.

Operation step:

- 1) Press any two buttons at the same time (for example: “” + “”) .
- 2) Connect handle and computer by USB cable, it means that the handle is powered by computer, loosen the buttons after the power supply.
- 3) Handle screen display:



The handle is connected with the computer successfully.

4) Open “ 此电脑”, could find a removable storage device”



”A0131482(G:) is the handle storage space area. User can copy files first and then paste them to A0131482(G:).

5) Connect handle and machine, Choose internal file to start processing.

Note: Users can view the hardware support capability in “version view”, if it supports “U disk mode” means it can realize U disk storage function.

PS3 G code reference list

G code list of A1X, B1X & B5X	
G00	Rapid positioning
G01	Linear interpolation
G02	Circular interpolation CW
G03	Circular interpolation CCW
G04	Dwell (Unit: millisecond)
G17	Selection of XY coordinate plane
G18	Selection of ZX coordinate plane
G19	Selection of YZ coordinate plane
G20	Input in inch
G21	Input in metric
G28	Auto back to reference point
G30	Back to secondary reference point
G40	Cancel tool radius compensation
G41	Left tool compensation(the tool offsets radius distance on the left side of tool moving direction)
G42	Right tool compensation(the tool offsets radius distance on the right side of tool moving direction)
G43	Tool length compensation (compensation along positive direction)
G44	Tool length compensation (compensation along negative direction)

G49	Cancel tool length compensation
G54	Work coordinate system 1
G55	Work coordinate system 2
G56	Work coordinate system 3
G57	Work coordinate system 4
G58	Work coordinate system 5
G59	Work coordinate system 6
G73	High-speed peck drilling cycle for deep holes
G80	Canned cycle cancel
G81	Drilling cycle
G82	Drilling cycle of dwell at bottom of hole
G83	Peck drilling cycle for deep holes
G84	Right hand tapping cycle
G90	Absolute programming
G91	Incremental programming
G98	Return to initial point
G99	Return to point R
G101	Move with processing speed until the signal is triggered. Meanwhile Rollback and pinpoint signal edge (similar to backing home)
G102	Move with fast speed until the signal is triggered. Meanwhile Rollback and pinpoint signal edge (similar to backing home)
G103	Move with processing speed until the signal is triggered.
G104	Move with fast speed until the signal is triggered.
M03	Spindle on(CW rotation)
M04	Spindle on(CCW rotation)
M05	Spindle stop
M06	Tool change
M08	Coolant on (Flood)
M09	Coolant off
M30	End of program, and return to program top
M37	Spindle on(CW rotation)
M38	Spindle on(CCW rotation)
M129	4th spindle on
M208	Cycle machining
M210	Set output logic low level
M211	Set output logic high level
M214	Run the next line of G code after waiting for the specified input signal logic low
M215	Run the next line of G code after waiting for the specified input signal logic high
M216	Run the next line of G code after waiting until all the specified input signal logic high

M217	Run the next line of G code after waiting until anyone of all the specified input signal logic high
M220	Set Y1 logic low level
M221	Set Y1 logic high level
M222	Set Y2 logic low level
M223	Set Y2 logic high level
M224	Set Y3 logic low level
M225	Set Y3 logic high level
M226	Set Y4 logic low level
M227	Set Y4 logic high level
M350	Set the extension output logic low level
M351	Set the extension output logic high level
T	Tool function
S	Spindle speed
F	Feed rate
H	Tool length offset

PS4 Tool setting details

The process of tool setting is process of setting work coordinate system specific location in the machine tool coordinate system.

There are 3 kinds of tool settings: **Direct tool setting**, **Fixed calibration** and **Mobile calibration**.

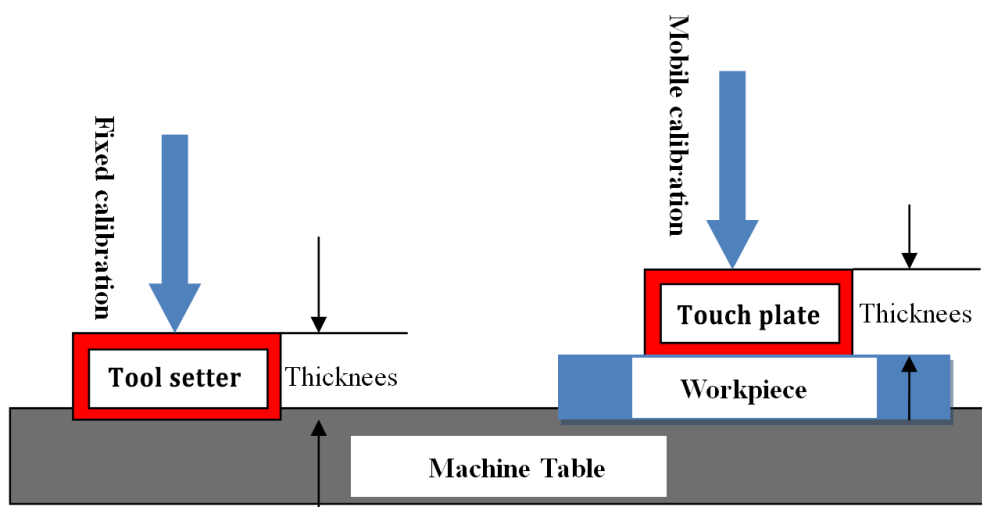

Tool setter, tool touch plate working sketch

PS4.1 Direct tool setting

Z axis move down towards directly and the cutter tool touches the material surface. Of course, user should reduce the motion speed of Z axis when the cutter is the most nearest the plane.

To confirm the contact position between the tool and the workpiece by eye-measurement or tool bit touch the workpiece surface. Then press “Z→0” to finish the manual tool setting.

PS4.2 Fixed calibration

Tool setter electrical wiring diagram:

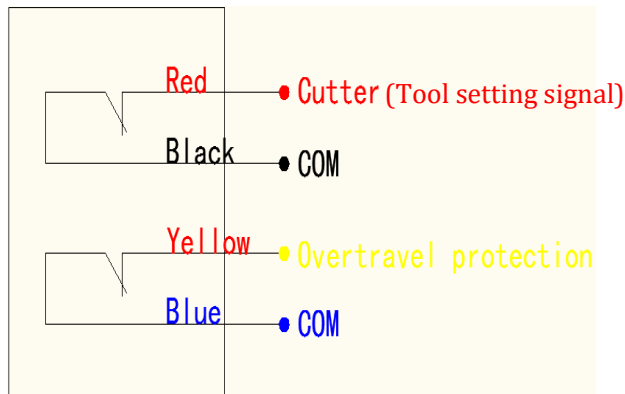

Wiring diagram



Real picture of tool setter

Tool setter wiring: The dsp controller tool setting input signal (X4) is normally open state when ex- factory.

Normally open type: The Tool setter signal CUTTER should be connected to the wiring board input port --X4, COM connects to GND-INPUT SIGNAL.

X4: system default normally open.

Normally closed: Firstly, modify the input voltage level of X4 to normally closed, then connect CUTTER signal to X4, COM to GND-INPUT SIGNAL.

The Over travel protection signal wiring method is similar to CUTTER signal. It can be connected to X7-E-stop signal.

Fixed calibration diagram:

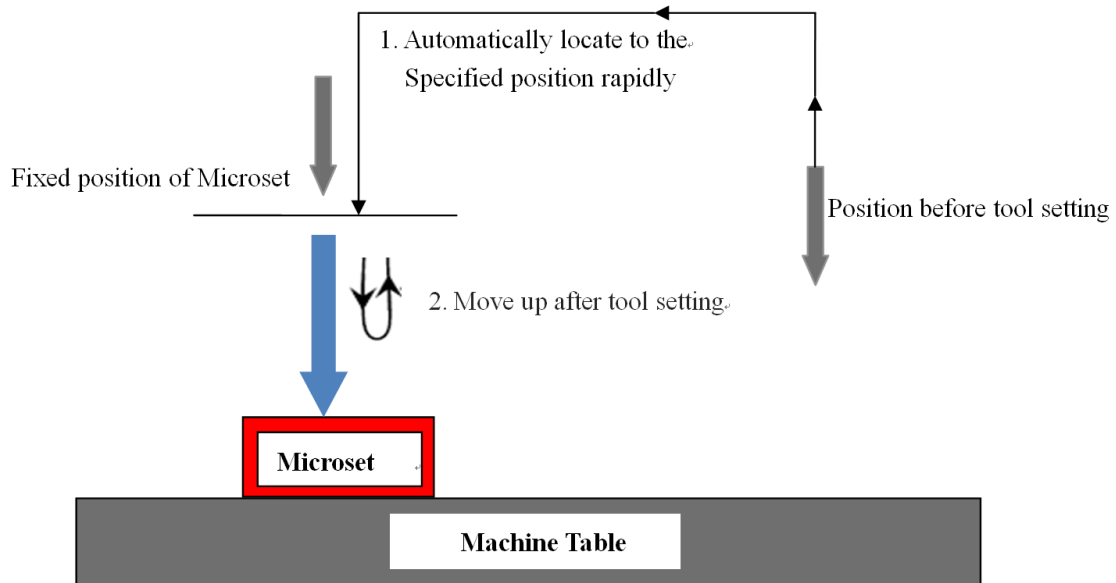

Fixed calibration: Means to execute tool setting operation at a certain fixed position on the machine table.

During machining, the cutter tool wear or fracture that needs replacement. However, the blade length and tool clamping position will change after tool changing. The system can execute “fixed calibration” to re-confirm the tool offset value.

Instructions:

1) Set Tool setter position

Get into “MACHINESETUP--C.A.D Position” to set Tool setter position, including “Inplace”&“Inposition”.



In position(positioning): Press“”, screen displays “Press OK key to set point position by manual mode, it’s very simple but not accurate, press cancel to set by number”. Recommend to choose manual mode.



In place: Move X,Y axis to the place where is over the Tool setter, press “”.

2) First time tool setting / Tool setting after tool changing

Manual move Z axis to the surface of workpiece, and set workpiece origin of X,Y,Z axis.

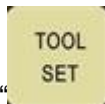

Press “” execute the first time tool setting. The system will record value of offset automatically.

Start the processing after first time tool setting.

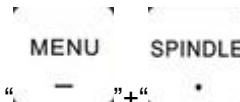

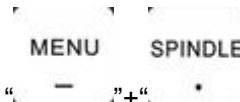
After the tool changed or tool bit broken, press “” to start second time tool setting, system will automatically restore to current Z axis workpiece coordinate origin.

Second time tool setting completed, start processing.

Note: After the tool changed or tool bit broken, the system can automatically calculate Z offset and save it when executes the tool setting command, after tool setting user can start processing directly without press “Z→0”.

PS4.3 Mobile calibration

Mobile calibration is suitable for materials such as wood working, acrylic, plastic, aluminum, iron, steel etc.

Generally, the tool touch-off plate can be used to do the mobile calibration, as it is economical, simple and convenient.

Tool touch-off plate wiring:

1. The white wire connects to X4(TS) input port on the wiring board.
2. The black wire connects to GND on the input terminal of the wiring board.

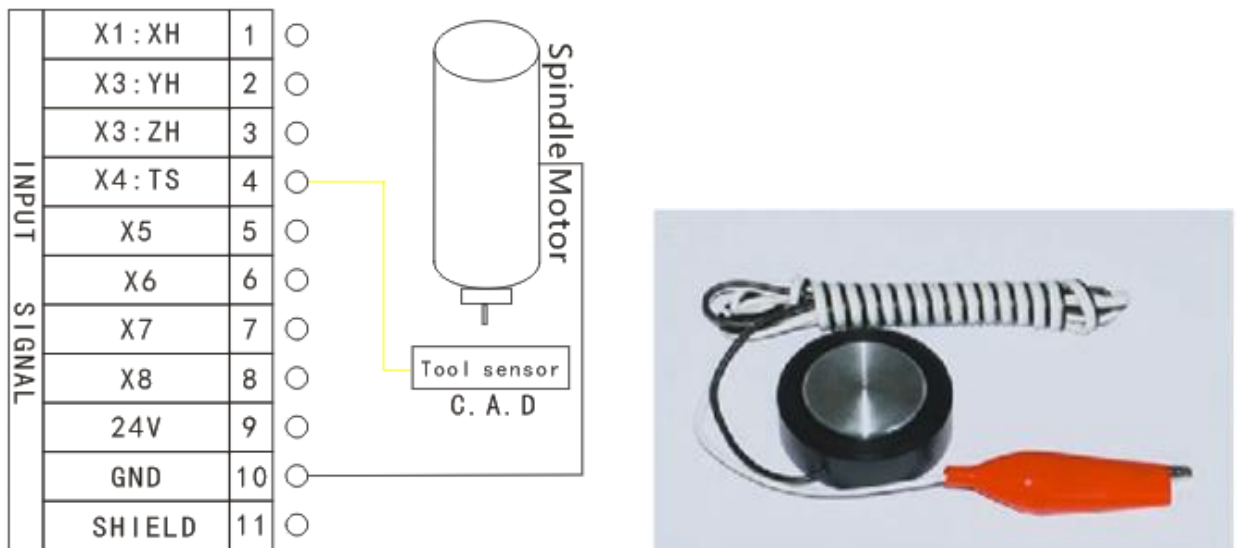

Usage method:

Connect the wire to the wiring board(X4 port), and connect the alligator clip to GND port on the interface board input terminal (or clamp it to the spindle, and ensure the spindle has been connected to earth wire).

Put the tool touch-off plate on the surface of the workpiece, move X Y axis over the tool

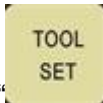
plate, press “”, Z axis will move down slowly until touches the plate and feedback its tool setting signal to the controller, then Z axis automatically lift up, tool setting complete.

Note: After connected the tool touch-off plate, start the machine (don't start the spindle). Don't put alligator clip on the spindle immediately, but to start automatically tool setting function first, and then use the alligator clip touch the tool touch-off plate quickly, in order to check whether Z axis has the action of tool setting. To ensure there is no problem with the spindle, and then realize the automatically tool setting.

The system “C.A.D thickness” value is default as 0, so the user should measure the real thickness of the tool touch-off plate and input the value into the system, under “Machine setup”—“C.A.D thickness”, after that user could use mobile calibration.

PS5 Pulse equivalent calculation

PS5.1 Stepper motor drive

PS5.1.1 Linear axis

Unit: Pul/mm

Formula = pulses per revolution / distance per revolution

Numerator:

Pulses per revolution formula: $(360^\circ / \text{stepper angle} * \text{Driver subdivision})$

(Some stepper drivers mark pulse number directly).

Denominator:

Distance/revolution formula:

Screw drive = screw pitch * mechanical transmission ratio (reduction ratio)

Rack (straight) drive = rack module * gear teeth number * π * mechanical transmission ratio (reduction ratio)

Rack (helical) drive = rack module * gear teeth number * π * mechanical transmission ratio (reduction ratio) / $\cos(\text{helical angle})$

Pulley & belt drive = π * pulley diameter * mechanical transmission ratio (reduction ratio)

✓ **Screw drive:**



$$\text{pulse} = \frac{\frac{360^\circ}{\text{Stepper angle}} * \text{Driver subdivision}}{\text{Screw pitch} * \text{transmission ratio}}$$

Pulse/rev	SW5	SW6	SW7	SW8
400	ON	ON	ON	ON
800	OFF	ON	ON	ON
1600	ON	OFF	ON	ON
3200	OFF	OFF	ON	ON
6400	ON	ON	OFF	ON
12800	OFF	ON	OFF	ON
25600	ON	OFF	OFF	ON
51200	OFF	OFF	OFF	ON
1000	ON	ON	ON	OFF
2000	OFF	ON	ON	OFF
4000	ON	OFF	ON	OFF
5000	OFF	OFF	ON	OFF
8000	ON	ON	OFF	OFF
10000	OFF	ON	OFF	OFF
20000	ON	OFF	OFF	OFF
40000	OFF	OFF	OFF	OFF

MSTEP	SW5	SW6	SW7	SW8
2	ON	ON	ON	ON
4	ON	OFF	ON	ON
8	ON	ON	OFF	ON
16	ON	OFF	OFF	ON
32	ON	ON	ON	OFF
64	ON	OFF	ON	OFF
128	ON	ON	OFF	OFF
256	ON	OFF	OFF	OFF
5	OFF	ON	ON	ON
10	OFF	OFF	ON	ON
25	OFF	ON	OFF	ON
50	OFF	OFF	OFF	ON
125	OFF	ON	ON	OFF
250	OFF	OFF	ON	OFF
DISABLE	OFF	ON	OFF	OFF
DISABLE	OFF	OFF	OFF	OFF



E.g.1:Driver nameplate1

E.g.2:Driver nameplate2

Motor nameplate/ stepper angle=1.8°

Explain: Stepper angle is the data of motor, means the angle of motor rotating for a single step. Driver subdivision is set in the driver.

In E.g.1, Pulse/rev is Pulses per revolution of stepper motor, so that the user only needs to select a relative value according to the actual dial code. For example: If user choose 3200 Pulse/rev, indicates $(360^\circ/\text{stepper angle}) * \text{Driver subdivision} = 3200$.

In E.g.2, the MSTEP means subdivision number. So, if the stepper angle is 1.8°, selected subdivision is 16, then $(360^\circ/\text{stepper angle}) * \text{subdivision} = (360^\circ/1.8) * 16 = 3200$.

The use should use correct computational method according to the actual marks of stepper motor driver nameplate.

Screw pitch (above picture): The distance that the nut moves when the ball screw makes one rotation.

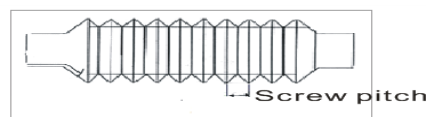

Transmission ratio: The reduction rate or angular velocity ratio of the front drive sprocket to the end driven wheel.

✓ **Rack drive:**

▶ **Straight teeth:**



$$\text{pulse} = \frac{\frac{360^\circ}{\text{Stepper angle}} \times \text{Driver subdivision}}{\text{rack module} \times \text{gear teeth number} \times \pi \times \text{transmission ratio}}$$

► Helical teeth:



$$\text{pulse} = \frac{\frac{360^\circ}{\text{Stepper angle}} \times \text{Driver subdivision} \times \cos(\text{helical angle})}{\text{rack module} \times \text{gear teeth number} \times \pi \times \text{transmission ratio}}$$

Explain: Rack module and gear teeth number are both the parameters of the rack. Rack module * gear teeth number * pi is the pitch circle circumference of the rack.

✓ **Pulley & belt drive:**

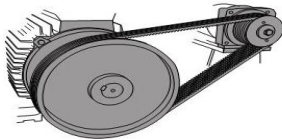

$$\text{pulse} = \frac{\frac{360^\circ}{\text{Stepper angle}} \times \text{Driver subdivision}}{\pi d \times \text{transmission ratio}}$$

d: Pulley diameter

PS5.1.2 Linear axis pulse equivalent calculation method

For example: the stepper motor driver dialed code is 1600 pulse/rev.

➤ **Screw drive**

screw pitch=5mm, pulse equivalent= $\frac{1600}{5} = 320$

➤ **Rack drive**

rack module: 1.25, gear teeth number: 23, π : 3.141592654, transmission ratio: 1/5(0.2)

helical angle: 19°31'42" ($\approx 19.52833333^\circ$)

Straight rack

$$\text{Pulse equivalent} = \frac{1600}{1.25 \times 23 \times 3.141592654 \times 0.2} = 88.573$$

Helical rack

$$\text{Pulse equivalent} = \frac{1600}{1.25 \times 23 \times 3.141592654 \times 0.2 \div \cos(19^\circ 31' 42'')}$$

$$= \frac{1600 \times \cos(19.52833333)}{1.25 \times 23 \times 3.141592654 \times 0.2} = 83.478$$

NOTES: $1.25 \times 23 \times 3.141592654 \times 0.2 = 18.0641577605$

$\cos(19.52833333) = 0.94247630504668681677372940102406$

$1.25 \times 23 \times 3.141592654 \times 0.2 \div \cos(19.52833333) = 19.1666969915 \approx 19.1667$

PS5.1.3 Rotary axis (pul/ °)

Formula = pulses per revolution / angles per revolution (360°)



$$\text{pulse} = \frac{\frac{360^\circ}{\text{Stepper angle}} \times \text{Driver subdivision}}{360^\circ \times \text{transmission ratio}}$$

PS5.1.4 Rotary axis pulse equivalent computing

E.g.: pulse/rev=1600, transmission ratio = 1/40

$$\text{Pulse equivalent} = \frac{1600}{360 \times 1/40} = 177.778 \text{ (result retains up to 3 decimal places)}$$

PS5.2 Servo motor drive

Electronic gear ratio numerator: resolution of the encoder can be found in the servo driver manual.

Electronic gear ratio denominator:

PS5.2.1 Linear axis

- ✧ Screw drive: pulse equivalent * screw pitch * mechanical transmission ratio
- ✧ Straight rack: pulse equivalent * rack module * gear teeth number * π * mechanical transmission ratio
- ✧ Helical rack: pulse equivalent * rack module * gear teeth number * π * mechanical transmission ratio / cos (helical angle)
- ✧ Pulley & belt drive: pulse equivalent * π * pulley diameter * mechanical transmission ratio

PS5.2.2 Calculate electronic gear ratio according to fixed pulse equivalent value

E.g.: Pulse equivalent of handle=1000

1. YASKAWA-Numerator Pn20E

YASKAWA Σ -7: Encoder resolution=16777216 (2^{24}) Set **Pn20E**=16777216

YASKAWA Σ -V: Encoder resolution=1048576 (2^{20}) Set **Pn20E**=1048576

YASKAWA- numerator Pn20E can set to 1048576

YASKAWA-denominator Pn210

- Screw drive

screw pitch=5mm, Pn210= 1000*5=5000

➤ Rack drive

rack module: 1.25, gear teeth number: 23, π: 3.141592654, transmission ratio: 1/5(0.2)

helical angle: 19°31'42" (≈19.52833333°)

◆ Straight rack

$$Pn_{210} = 1000 \times 1.25 \times 23 \times 3.141592654 \times 0.2 = 18064$$

◆ Helical rack

$$Pn_{210} = 1000 \times 1.25 \times 23 \times 3.141592654 \times 0.2 \div \cos(19.52833333) = 19167$$

2. DELTA ASDA-B2&A2

B2: Encoder pulses equivalent default--N=160000

A2: Encoder pulses equivalent default--N=1280000

E.g.: B2 series N=160000

➤ Screw drive

screw pitch=5mm, Denominator M=1000×5 = 5000

$$\text{Electronic gear ratio} = \frac{N}{M} = \frac{160000}{5000} = \frac{32}{1}$$

Set P1-44=32, P1-45=1

➤ Rack drive

rack module: 1.25, gear teeth number: 23, π: 3.141592654, transmission ratio: 1/5(0.2)

helical angle: 19°31'42" (≈19.52833333°)

◆ Straight rack

$$\text{Denominator } M = 1000 \times 1.25 \times 23 \times 3.141592654 \times 0.2 = 18064$$

$$\text{Electronic gear ratio} = \frac{N}{M} = \frac{160000}{18064} = \frac{10000}{1129}$$

Set P1-44=10000, P1-45=1129

◆ Helical rack

Denominator M=1000×1.25×23×3.141592654×0.2÷cos (19.52833333) =19167

$$\text{Electronic gear ratio} = \frac{N}{M} = \frac{160000}{19167}$$

Set P1-44=160000, P1-45=19167

PS5.2.3 Calculate pulse equivalent according to fixed electronic gear ratio

DELTA ASDA-B2: Electronic gear ratio default--16/10,

A2: Electronic gear ratio default--N=128/10

E.g. B2: Set P1-44=1, P1-45=1, Encoder pulses equivalent 2500×4=10000

➤ Screw drive

screw pitch=5mm, pulse equivalent = $\frac{10000}{5} = 2000$

➤ Rack drive

rack module: 1.25, gear teeth number: 23, π: 3.141592654, transmission ratio: 1/5(0.2)

helical angle: 19°31'42" (≈19.52833333°)

◆ Straight rack (results retain up to three decimal places)

$$\text{Pulse equivalent} = \frac{10000}{1.25 \times 23 \times 3.141592654 \times 0.2} = 553.582$$

◆ Helical rack (results retain up to three decimal places)

$$\text{Pulse equivalent} = \frac{10000}{1.25 \times 23 \times 3.141592654 \times 0.2 \div \cos (19^{\circ}31'42'')} = 553.582$$

$$= \frac{10000 \times \cos(19.52833333)}{1.25 \times 23 \times 3.141592654 \times 0.2}$$

$$= 521.738$$

PS5.2.4 Rotation axis

Electronic gear ratio denominator: Pulse equivalent * 360 * transmission ratio (reduction ratio)

- 1) Pulse equivalent of handle fixed to 1000

YASKAWA Same to linear axis

YASKAWA Σ -7 electronic gear ratio numerator

$$\mathbf{Pn20E=16777216,}$$

YASKAWA Σ -V electronic gear ratio numerator

$$\mathbf{Pn20E=1048576}$$

transmission ratio = 1/40 , electronic gear ratio denominator
 $\mathbf{Pn210=1000 \times 360 \times 1/40=9000}$

DELTA Same to linear axis

DELTA ASDA--B2 Encoder pulses default--N=160000

A2 Encoder pulses default--N=1280000

E.g. B2: Electronic gear ratio numerator N=160000

Electronic gear ratio denominator M=1000×360×1/40=9000,

$$\text{Electronic gear ratio} = \frac{N}{M} = \frac{160000}{9000} = \frac{160}{9}$$

Set P1-44=160, P1-45=9

- 2) Calculate pulse equivalent according to fixed electronic gear ratio, set P1-44=1, P1-45=1

Encoder pulse count per revolution $2500 \times 4 = 10000$

Pulse equivalent = $\frac{10000}{360 \times 1/40} = 1111.111$ (results retain up to three decimal places)

PS5.3 Proportion calculation method

If there is an error when calculate it according to the formula or cannot get relevant data to calculate, it can be calculated according to the proportion method. Suppose handle pulse

equivalent is A, press "" switching to distance mode, set a distance B, measuring the number of actual moving distance C, then the actual pulse equivalent = $A \times B \div C$.

For example: Suppose handle pulse equivalent A = 400, distance B = 100, actual distance C = 80, then the actual pulse equivalent = $400 \times 100 \div 80 = 500$

Repeat calculation for several times until you get the correct pulse equivalent value.

PS6 Common troubleshooting

PS6.1 Solution of screen prompts fault information



1. After powered on the "Screen flicker or automatically restart"

- 1) Switching mode power supply is insufficient. Check power supply if there are problems, and change high-quality power supply to solve the problems.
- 2) The local power grid unstable. Check local grid voltage stability or use the regulator filter device.
- 3) The power chip of the handle is ageing. This phenomenon also appears when the handle is powered through the USB cable to the computer. Please return back the handle to our company.

- 4) Temporary solution. Using standard 5V mobile phone charger, supply power through the USB cable to handle. Duplicate power supply for temporary emergency use.

2. Failed to set work piece origin during normal operation process

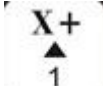
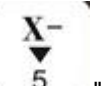
- 1) It is under the mechanical coordinate system. Check if the main interface displays AX

AY AZ, if yes, should press " - " + " 5" switching to work coordinate system. Then it can set work origin. Press " -  0" is for going to mechanical coordinate system where cannot set work origin in there.

- 2) The buttons are broken. Go to "SYSTEM SETUP"-“Buttons Check” menu to check whether the buttons are normal or not.

3. Assertion error

Assertion error (occurred during the processing or after starting) is generally a software problem. User can boot the controller by entering “emergency state”, or re-upgrade it. If can't be solved either, user should send back it for repairing.

4. Unable to read U flash disk or read error occurs

- 1) Processing by U-disk, screen shows “there is no item in this option”. Format U-disk to FAT32, change allocation unit to the default configuration size. Then re-import processing files, it will read normally.
- 2) U flash disk capacity is too large (16G, 32G or 64G etc.). Recommend replace U disks such as 2G、4G、8G.
- 3) There is something wrong with USB communicate port or U-disk interface is broken, change a new USB port or U-disk.
- 4) There is no any reaction while insert into the U-disk. Change a genuine brand of U-disk, such as SanDisk, FOUNDER U-disk etc.
- 5) If the U-disk interface is weak connection, user can copy files into inner memory space of the controller for temporary solution.
- 6) Program contains non-standard G codes, or some illegal characters. The system does not recognize them and interrupt handling. Recommend using professional

simulation software to review the program whether there is an illegal character.

Delete all illegal characters.

PS6.2 FAQ in practical operation

1. After the machining, the cutting size doesn't match the actual size in processing file

- 1) Pulse equivalent is wrong.
- 2) User has selected the wrong tool bit which is not the same as it set in process file.
- 3) Check if there is any problem with the path processing file.

2. The screen displays "exceed limit" during processing

- 1) The machine hasn't returned ZERO, lead the system is unable to confirm the actual position. Solution is to go machine ZERO.
- 2) The reserved processing range is small than the actual file size after user set work piece origin. Confirm the actual file size and then set a correct working origin.
- 3) Set wrong working origin in the process of creating processing file path. Check the file path, and then generate the correct one.

3. Hard limit triggering

- 1) If the machine has connected with hard limit, the hard limit switch maybe damaged or the voltage setup status on X6 is wrong.
- 2) System has not connected with hard limit signal: Confirm whether connect other signal wire to hard limit X6 port, if not, check voltage setup normal or not. If normal, user could go to "MACHINE SETUP"- "Input Confi" and DISABLE X6 port, then go to "SYSTEM SETUP"- "wipe cache". If still can't solve this problem, user can upgrade the system.

4. Z axis (spindle) fall down abnormally (too fast) and cause Z feed amount too much during processing

- 1) Z axis working speed exceed the fastest speed cause Z axis loses its steps when moving up. " MACHINESETUP " - " Max Spd Limit ", set the safe speed.
- 2) The coupling is loosen or transmission mechanism slipping. Re-adjustment the connecting parts.

- 3) The signal wire connected between the interface board and the motor driver has got interference. Adjust the circuit.
- 4) Processing file error. Check processing file, try to download the correct processing file to U disk or handle internal.
- 5) There is something wrong (plug loosen or wire damaged or wire diameter is too slimy) with the lines connecting Z axis motor and motor driver. Replace the lines.

5. Repeating the same processing file after returning back to the machine

ZERO, Z axis cutting depths are not as same as each other

- 1) Machining table is uneven or processing object not firmly fixed, re-milling the machine table to adjust the flatness.
- 2) Z-axis origin detection switch repeat positioning accuracy error, causing Z axis homing error each time. Replace a high-quality detection switch.
- 3) Too much interference in the Z-axis homing process to form a false Z origin. Re-adjust the wiring.

6. The machine cannot stop after returning ZERO, and cause spindle hit the machine body



Double press“”to check input signal (Origin detection switch signal). To do self test. Detect whether the signal is triggered or disconnected.

- 1) The origin detection switch is broken. Replace a new one.
- 2) The distance of the origin detection switch detection sheet beyond the detection range(This problem is common occurs in optoelectronic and proximity switches) of the switch, adjust the position of the test piece.
- 3) The origin detection switch to the interface board wiring aging or loosening. Check the connections again.
- 4) The interface board is broken. Return back o us to repair.
- 5) 50-pin data cable is broken. Replace it with a new data cable.

7. The machine uniform moves to the reverse direction when backing to the machine ZERO

- 1) The origin detection switch types do not match with the definition of the corresponding voltage level. Modify the voltage level in the controller. (Normally open type corresponds to a level defined the direction of the arrow down, normally closed type corresponds to the level defined arrow up).

- 2) The origin detection switch is broken. Replace a new one.
- 3) The origin detection switch connects interface board not well. Refresh the cable to confirm the wiring is correct.
- 4) Too much interference, resulting in the illusion of the detection switch has been triggered. Recalibrated the whole circuit.
- 5) The interface board is broken. Depot Repair.
- 6) 50-pin data cable is broken. Replace the data cable.

8. Abnormally running when processing or the actual file is different from theoretical file

- 1) The system program disorder.
- 2) Too much external interference lead the controller cannot work normally. Re-adjust overall circuit. (The wires of weak current and strong current should be separately binding, the inverter and other components should be separated connected each GND of themselves).
- 3) There is something wrong while converting the file format and the program appears illegal characters or system unrecognized codes. Recommended to use third party simulation software to review the program paths.

9. Start automatic tool setting, the tool does not stop after touching C.A.D (Tool sensor).

- 1) The cutter signal cable connects X4 maybe broken circuit.
- 2) The "GND" signal port on the interface board hasn't been connected with spindle housing or poor connection.
- 3) Go to "MACHINE SETUP"- "Input Confi" to confirm if X4 is enabled.

10. Coordinate value changes on screen, but the machine does not move

- 1) If it is one axis not moving, it maybe wiring problem. Change another normal terminal to this axis wiring terminal, if it moves properly indicating the rear parts of motor driver have no problem. Check if there is something wrong with interface board or 50-pin cable. If it is still not moving, it is necessary to detect the corresponding drive and motor.
- 2) If all axes are not moving, firstly, check if there are problems in the 50-pin cable and interface board,; secondly, if the interface board and 50-pin cable are normal, then user should check the power supply of the motor drivers.
- 3) If debugged all above parts, but the machine still not move, then the mechanical parts should be checked.

11. It is normal to the move from one position to another position, but when return from that position to the original position is not normal

Mechanical assembly problem, guide screw may be not installed well.

12. Motor moving direction is wrong

- 1) Exchange A+&A- or B+&B- cable of the stepper motor
- 2) Change motor direction mask (not recommend)

13. The machine vibrates when moves in arc or two-axis linkage movement

- 1) Check whether the machine is placed horizontally
- 2) Check if the coupling units loose or not.
- 3) Increasing the “start speed”, avoid the resonance point.

PS6.3 Electrical components and wiring problem

1.A single axis or multi axis can only in one direction after machine power on

- 1) There is something wrong with the connecting between the interface board and motor driver common anode end, check the connection.
- 2) Interface board is broken. Replace the interface board.
- 3) The motor driver is broken. Replace the driver.
- 4) Measure the direction voltage of that axis with a multimeter. Check if the direction is correct.

2.One axis motor does not move after handle power up

- 1) Pulse cable and direction cable connect oppositely, adjust connection sequence..
- 2) 5V common anode end of the motor driver disconnected, check the connection.
- 3) The motor driver is broken (Performance as the motor moves when push it by hand), change a new one.
- 4) The interface chip of the interface board is broken, no pulse signal output.
- 5) Switch this terminal with another normal terminal to check interface board abnormal or driver abnormal.

3. Screen is not bright after power up, but connect the handle to computer with USB cable the screen displays normally

- 1) The DC24V voltage of the handle is not available. Check if the DC24V power supply voltage output is normal or not. If normal, please check if the cable from the power supply to the interface board is virtual connection.
- 2) The 50-pin cable is broken or 50 pin connecting plug hasn't connected well.

4. Screen is not bright neither after power up nor connect to computer by USB cable

- 1) This phenomenon may due to the handle shocked by external force or fall on the ground, causing the crystal processor broken. Return back to repair.
- 2) Users connect high voltage power supply to the interface board and cause the handle and interface board broken. Return back to repair.

5. The screen display “Spindle on”, actually the spindle off; the screen display “Spindle off”, actually the spindle on

- 1) Line fault. Spindle on signal and COM port is short circuit. Check circuit line.
- 2) The output level definition reversed. Go to the “voltage setup” and modify the output level definition (modify the left first arrow direction in the second row).

6. The handle screen doesn't light up and shows nothing after power on

- 1) The power supply voltage is too large or the + and – short circuit burned the chip. Return to us for repairing.
- 2) The power supply damaged, change a new one.
- 3) 50-pin cable is broken, replace it.
- 4) 50-pin socket broken, send back to us for repairing.

7. System always alarm after the alarm signal has been connected

Change the input level on X5 (normally open, wiring in parallel; normally closed, wiring in series).

8. Press “spindle on” button, but spindle does not start

- 1) Check wiring, if normal, check if the inverter has alarm, if the inverter is normal and its setting is correct, and then check if the spindle motor damaged or not.
- 2) Check if 50-pin cable is loose. Confirm the settings of inverter refer to its manual to debug one by one.

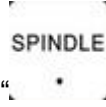

- 3) Check interface board. Press“ ” to start spindle, use multimeter to measure Y1 and GND to see whether conducting, if not, interface board or 50-pin cable is broken. To replace a new one for trouble clearing one by one.